



seit 1984 ®

AIR fair
EMISSIONSMESSTECHNIK

MGAprime Q

USER MANUAL



Manufacturer:



**MRU · Messgeräte für Rauchgase
und Umweltschutz GmbH**

Fuchshalde 8 + 12

74172 Neckarsulm-Obereisesheim

Fon 07132 99620 · Fax 07132 996220

info@mru.de · www.mru.eu

Legal notices / Intellectual property rights comments

Original user manual

© 2022 by MRU

No part of this manual may be published in any form (print, photocopy, electronic media or any other publication form) without a written approval by the publisher.

All user trade marks and name mark descriptions, even those which are not marked as such, are properties of the respective owners.

Edition: 2022-09-21, V4.20.EN

Table of content

1 Information for product and safety 7

1.1. Safety manual7

1.2. Safety precautions.....7

2 Introduction 8

2.1. Intended use9

2.2. About us 11

3 Description 12

3.1. Task..... 12

3.2. Gas flow diagram..... 12

3.3. Analyser..... 13

3.4. Connectors..... 14

3.5. Heated Gas sampling probe..... 15

3.6. Gas conditioning..... 16

3.7. Gas supply 16

3.8. Gas sensors 17

3.9. Acid injection 17

4 Operation 19

4.1. Commissioning..... 19

4.2. Operating panel..... 19

4.3. Charging the battery 20

4.4. Switching on the analyser 21

4.5. Switching off the analyser 21

4.6. Turn Display..... 21

4.7. Set the analyser to standby mode 22

4.8. Back to homescreen / Back to measure..... 23

4.9. Create screenshots..... 23

5 Settings..... 24

5.1. Open menu Settings 24

5.2. General settings 24

5.3. Setting Date and Time 25

5.4. Device settings 27

5.5. Water monitoring..... 28

5.6. Averaging 31

5.7. Interval measurement..... 33

5.8. Programs 37

5.9. Analog output setup (4-20mA) 38

Setting channel 38

Setting lower / higher limit..... 39

Setting Analog outputs during zeroing 40

Pin assignment of the 4-20mA interface (Analog IN / OUT)..... 41

5.10. Analog input setup (4-20mA)	42
5.11. Connecting analyser with WIFI (WLAN)	43
5.12. Getting information about the network.....	44
5.13. Assigning a static IP address	45
5.14. Serial connectivity (RS485/USB)	46
5.15. Default settings	48
5.16. Configuration of measurement program	49
Test program.....	49
Measurement program	49
Further measuring programs	50
Moving a value field.....	50
Assign a measured value	50
Setting zoom.....	51
6 Measurement	52
6.1. Prepare measurement.....	52
Operating temperature	52
Power supply.....	52
Opening the transport bag	53
Connections to the analyser	53
Plug in temperature sensor	54
Switch-on, warm-up phase, zero point	55
Attach clip-on filter.....	56
Controlling Filters.....	57
Connecting Acid Dosing Unit APE.....	57
Repeated Zero point	59
Automatic zero point	60
Charging state of the battery.....	60
6.2. Take a measurement.....	60
Starting the measurement	60
Setting O ₂ -Reference	61
Storing measured values	61
Selecting channels for graphic display	62
Starting Auto-measurement.....	64
7 Data storage.....	67
7.1. Organizing data storage	67
7.2. Managing sites	67
Adding a new site.....	67
Changing site data	68
Deleting sites	69
Recalling stored measurements.....	70
Delete stored measurements.....	70

7.3.	Data transfer via USB (CSV export)	73
8	Extras	76
8.1.	Open menu Extras.....	76
8.2.	History	76
8.3.	System extensions.....	78
8.4.	Connections.....	80
8.5.	Automatic device start.....	80
8.6.	Instrument leak test.....	81
8.7.	Printing measurement results	84
	Printing current measurement results	85
	Printing stored measurement results.....	85
9	Service	87
9.1.	Open menu Service	87
9.2.	Service values.....	87
9.3.	Performing Device selftest	88
9.4.	Internal log settings.....	89
	Copying all log data	89
	Copying single log data.....	90
	Export NDIR- Factors	92
10	Info	93
10.1.	Open menu Info.....	93
10.2.	Calling up device info	93
10.3.	Device usage	94
11	Entering Pin code.....	95
12	Calibrating NDIR cuvette	96
12.1.	Connecting analyser to sample gas cylinder.....	96
12.2.	Open adjustment window.....	97
12.3.	Perform a 2-point adjustment.....	98
12.4.	Perform a 1-point adjustment.....	102
13	Maintenance and cleaning.....	105
13.1.	Cleaning and maintenance	105
13.2.	Service check.....	105
14	Transport and storage.....	106
15	Simple service work.....	107
15.1.	Information of the analyser components	107
15.2.	Updating the firmware	108
	Update main firmware.....	108
	Update firmware of single modules.....	111
16	Specifications	114
16.1.	Specifications of NDIR technology	114

16.2. Sensors for Oxygen, Temperatures and Pressure.....	115
16.3. Gas sampling and conditioning	115
16.4. Calculated values and accessories.....	116
16.5. Data communication.....	116
16.6. Technical data	116
16.7. Technical data Acid Dosing Unit APE.....	117
17 Options.....	118
17.1. Gas flow measurement.....	118
Connect analyser to Pitot tube.....	118
Parameter for gas flow measurement	119
17.2. Operating analyser with Nickel Metal Hybrid (NiHM) Battery.....	120
17.3. RS485 Extern.....	121
17.4. Screw adapter onto HPI-Probe (Option).....	122
18 Appendix.....	123
18.1. Error diagnosis regarding the measuring instrument.....	123
18.2. Condensate alarm	124
Condensate self help.....	124
Start drying manually.....	125
18.3. Switching off the analyser in case error	127
18.4. Connecting analyser with MRU4win.....	127
Connecting analyser with MRU4win via serial interface (RS 485).....	127
Connecting analyser with MRU4win via TCP/IP connection.....	128
Creating analyser in MRU4win	129
18.5. Remote control of the analyser device via VNC.....	132
18.6. CxHy Calculation.....	133
18.7. General Instructions for the heated hose line.....	133
Unrolling the heated hose line	134
Bending radius of heated sampling lines	135
18.8. Spare parts	135
19 Declaration of conformity.....	136

1 Information for product and safety

1.1. Safety manual

All general information and safety precautions of MRU products are listed in the supplied separate safety manual.

All information and safety precautions for the analyser MGAprime in the Safety Manual also apply to the analyser MGAprime Q.

Therefore, this manual must be read and observed before the first use of the instrument.

Instrument-specific safety and warning requirements in this manual are prefixed before dangerous actions.

1.2. Safety precautions

The used categories of safety precautions are here explained once more.



⚠ DANGER

Identifies an immediate, impending hazard that, if ignored, will result in severe bodily injuries or death.



⚠ WARNING

Identifies an immediate, impending hazard that, if ignored, may result in severe bodily injuries, material damage or death.



⚠ CAUTION

Identifies a possibly dangerous situation that, if ignored, may result in minor injuries.



ATTENTION

Identifies a possibly harmful situation that, if ignored, may result in damages to the device or its surroundings.



NOTE

Identifies user tips and other especially important information.

The explanation of safety notices:



⚠ CAUTION

HOT – danger of burns and fire hazards from gas extraction probe.

Physical harm and property damage can be caused.

► Cool down the probe tube.

2 Introduction

- Read and observe the separately supplied Safety manual.
- This manual enables you to understand and safely operate this MRU Analyser **MGA**prime Q.
- Please read this manual with great vigilance.
- Get familiar with the product before using it.
- This analyser may only be operated by competent personnel and for its intended use.
- The analyser may only be used by qualified personnel for the intended use.
- Please pay special attention to all safety directions and warnings to prevent personal injuries and damaging of the product.
- We can't be held responsible for any injuries and/or damages that occur by not following the instructions in this manual.
- Always keep the manual near you when working with the analyser, to be able to read instructions as needed. Please ensure to hand over all documents to when handing the analyser over to others.
- Hand over all documents when passing on the analyser to third parties.

2.1. Intended use

The analyser MGAprime Q is proofed according to DIN EN 15267-4.

The following table lists proofed and non-proofed measured values.

Measured variables and conversions.	Proofed according to 15267-4	Notes
O ₂	✓	
CO	✓	
NO	✓	
NO ₂	✓	
CO ₂	✓	
SO ₂	✓	
N ₂ O	✓	
Flue gas temperature	-	
Air temperature	-	Measurement of the ambient temperature
Draft / Differential Pressure	-	
Velocity (v)	-	Measurement with Pitot tube
ppm -> mg/Nm ³	-	
NOx: mg/Nm ³ NO ₂	-	
O ₂ Ref	-	
mg/kWh	-	

The proof according to DIN EN 15267-4 was performed under the following conditions:

Grip heating temperature	160 °C
Heating hose temperature	160 °C
3m Heating hose	
Zero-point interval	deactivated

The following functional modules are not part of the proof according to DIN EN 15267-4:

- Data Storage
- Internal logger

The Analyser **MGA**prime-Q is designed for the gas analysis of flue gases, as they are emitted from gas/oil burners, engines, or heating and power appliances.

The analyser is intended to support the user in control and indicative measurements in an efficient, accurate and reliable way.

The analyser is specifically not intended as a safety device or personal protective equipment.

The analyser should not be used as a warning device to warn people against the presence of harmful gases.

The analyser was manufactured according relevant standards and regulations.

The analyser must be used according to instructions for the intended use.

▲ WARNING**Risk from manipulations to the measuring device**

Operational safety hazard

- ▶ Modifications or changes to the measuring device are not allowed.

Syntax

Please note that this manual makes use of the scientific notation of gases (NO₂), while the instrument itself and its screen shots display the gases in upper case letter only, i.e. (NO2).

2.2. About us

The analyser is produced by the MRU GmbH in Neckarsulm, Germany (Founded in 1984), a medium sized company that is specialised in developing, producing and marketing high quality emission monitoring analysers.

MRU GmbH produces a wide range of instruments, from standard analysers up to tailor made industrial analysers.



Building 1: Sales, Service, R&D



Building 2: Production

MRU GmbH
Fuchshalde 8 + 12
74172 Neckarsulm - Obereisesheim
GERMANY
Tel +49 71 32 99 62 0 (Front office)
Tel +49 71 32 99 62 61 (Service)
Fax +49 71 32 99 62 20
Email: info@mru.de
Site: www.mru.eu

3 Description

3.1. Task

The main task of the analyser is to analyse flue gases, as they are emitting from incinerators or engines.

- The analyser is optimized for this purpose and includes all components from the gas sampling probe to data processing.
- The analyser also performs other measurement tasks such as pressure and temperature measurement or measurement of flow velocity.¹

For an overview on all available options please refer to the company's home page or sales representatives.

3.2. Gas flow diagram

In combination with the gas sampling probe, the analyser extracts a partial volume of the flue gas from the combustion channel and analyses it for its components by means of sensors (e.g. paramagnetic (oxygen) sensor or NDIR sensors).

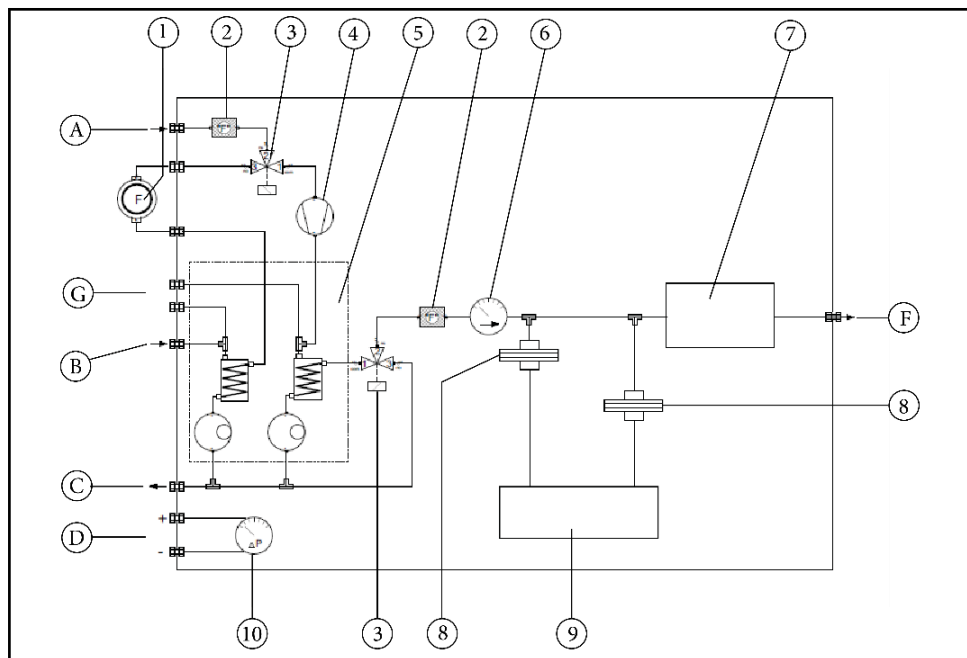

A	Fresh air inlet	B	Sample gas inlet
C	Condensate outlet	D	Diff. Pressure connector
F	Gas outlet	G	Acid injection

¹ Pressure, temperature and velocity measurements are not part of the proof according to DIN EN 15267-4. See also chapter 2.1 Intended use, Page 8.

1	Sample gas filter (PTFE)	2	Dust filter
3	Auto-zero solenoid valve	4	Sample gas pump
5	Double stage gas cooler	6	Sample flow sensor
7	Paramagnetic oxygen sensor	8	Acrodisc PTFE filter
9	Infrared (NDIR) bank	10	Diff. pressure sensor

3.3. Analyser

The Analyser consists of a compact and robust metal housing with shock-absorbing rubber corners. All electrical and pneumatic connections are located on the both front sides of the analyser. The analyser is operated exclusively via the touch-sensitive touch screen.

The analyser is delivered in a water resistant bag.

During measuring operation, the analyser must be placed in the Water resistant bag. The water-repellent bag is part of the analyser.



3.4. Connectors

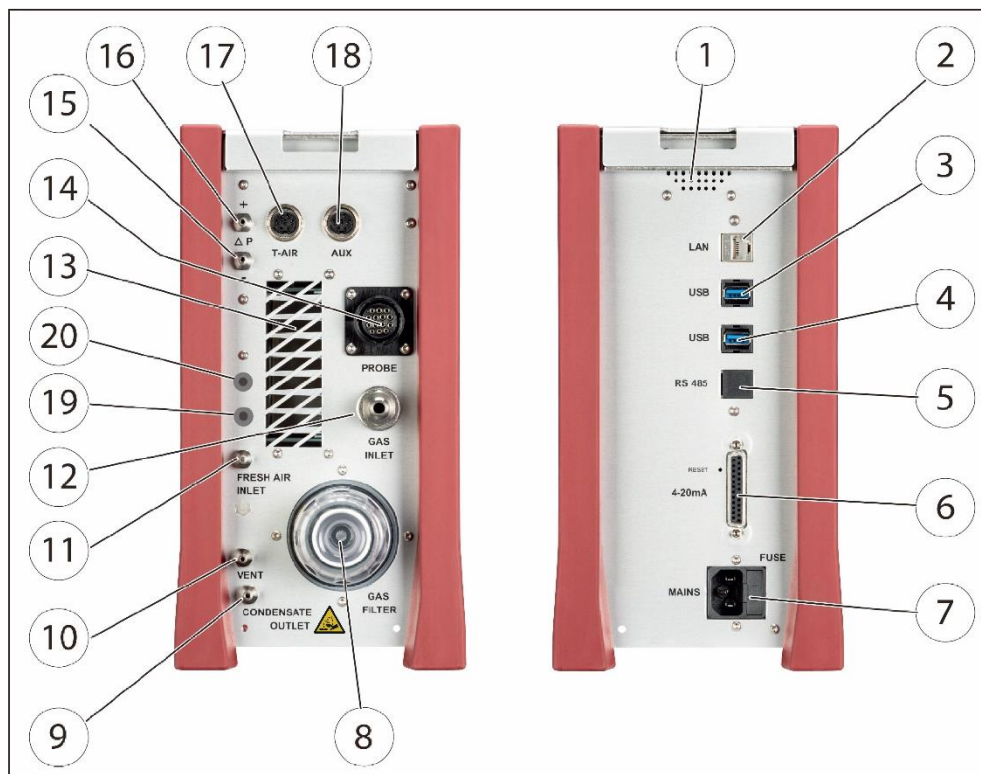

Front side right			
1	Loudspeaker	2	Ethernet (LAN)
3	USB socket	4	Second USB socket (option)
5	RS485 (Option)	6	Analog outputs 4 ... 20 mA Analog-inputs 4 ... 20 mA
7	Mains power supply		

Front side left			
8	Sample gas filter	9	Condensate outlet port Hose connection DN 4/6
10	Sample gas outlet port (VENT) Hose connection DN 4/6	11	Fresh air inlet port
12	Sample gas inlet port	13	Outlet fan of gas cooler
14	Probe connection, electrical	15	Pressure-/diff. pressure
16	Pressure-/diff. pressure (Absolute pressure)	17	Combustion air temperature
18	AUX socket	19	Connection acid injection
20	Connection acid injection		

3.5. Heated Gas sampling probe

For interchangeable probe tube with flue gas temperature measurement using type K-thermoelement.²

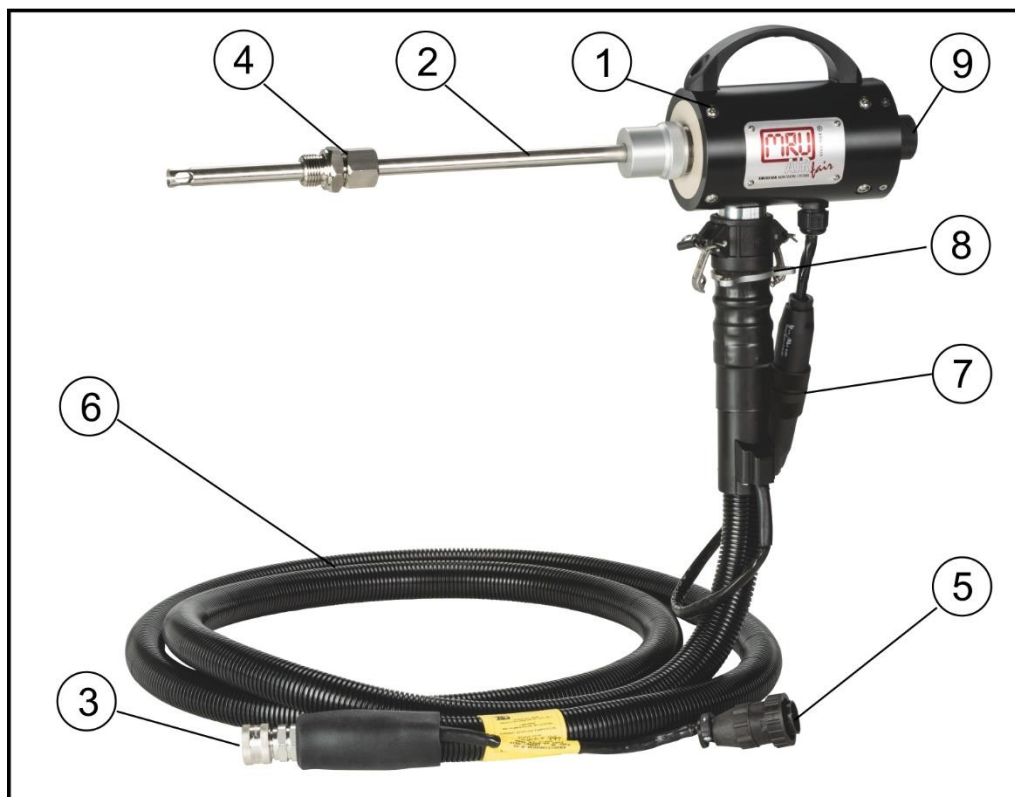

1	Probe handle	2	Probe tube
3	Fast locking coupling	4	Probe cone
5	Cable plug (14-pin)	6	Heated hose line
7	Cable coupler (5-pin)	8	Fast locking coupling
9	Filter lock		

► Check the probe filter before and after each measurement.

⚠ WARNING



Danger of burns and fire hazards from Heated hose line

Injuries and burns may result.

► Roll out the heated hose line completely for each measurement.

² The measurement of the flue gas temperature is not part of the proof according to DIN EN 15267-4. See also chapter 2.1 Intended use, Page 8.

ATTENTION

When measuring with coiled heated hose line, the hose line is destroyed due to strong heat development.

- ▶ Roll out the heated hose line completely for each measurement.

NOTE

Please note that heating hoses with 110V and 230V are offered.

- ▶ Check the voltage supply of the heating hose before commissioning.
- ▶ You can operate a 230V heating hose with 110 volts, but with limited heat capacity.

⚠ DANGER**Risk due to improper use**

Risk of death due to electric shock

- ▶ Do not operate a 110V heating hose with 230V.

☞ See also chapter 18.7 General Instructions for the heated hose line, Page 133.

3.6. Gas conditioning

The sucked sample gas is dried and filtered before it is fed to the sensors.

A sample gas cooler with Peltier element is used for drying.

The condensate liquid appearing in the gas cooler is pumped to the condensate outlet by means of a peristaltic pump. The condensate forms drops at the outlet of the instrument.

Optionally, connect a hose (DN 4/6) to the condensate drain.

The VENT output delivers the sample gas after the analysis stage.

For subsequent filtering, a round filter is used on the front of the analyser.

3.7. Gas supply

The analyser contains a gas feed pump (diaphragm pump).

The flow through the gas feed pump is measured and regulated to the nominal value by the analyser. The analyser requires a gas flow of at least 50 l/h.

If the pump capacity is not sufficient to reach the flow of the nominal value, an alarm is issued.

If the flow does not reach the nominal value despite an increase of the pump capacity, the pump is switched off after a while to protect the analyser.

3.8. Gas sensors

The analyser has two types of gas sensors:

1. The analyser works with a paramagnetic sensor for the Measurement of O₂ (oxygen).
2. The analyser works with a non-dispersive infrared absorption measurement. With this measuring principle it is possible to measure CO (carbon monoxide), CO₂ (carbon dioxide), NO nitrogen monoxide, NO₂ (nitrogen dioxide), N₂O (nitrous oxide) and SO₂ (sulphur dioxide).

3.9. Acid injection

⚠ CAUTION**Phosphoric acid (10 %)**

Phosphoric acid (10 %) may cause burns.

- ▶ If you come into contact with acid, wash the area immediately using a lot of water.
- ▶ Note the safety data sheet for phosphoric acid (10%).

Phosphoric acid (10 %) is injected into the analyser using the Acid Dosing Unit APE.



The injection of phosphoric acid (10 %) is necessary for a correct measurement.

- The injection guarantees constant conditions in the gas cooler, so that you can measure dry or humid flue gas.
- The use of phosphoric acid (10%) reduces losses of SO₂, NO₂ on the humid surfaces of the gas cooler.

Both effects increase measurement accuracy by preventing slow drift effects caused by slowly forming or saturating moisture films.

Two pumps inject 24ml (2*12ml) of phosphoric acid (10%) per hour during the measurement.

- ☞ See also chapter Connecting Acid Dosing Unit APE, Page 57 to connect the Acid Dosing Unit APE to the analyser.

NOTE





Observe the consumption of the phosphoric acid. If the consumption of the phosphoric acid decreases, there may be a defect in the supply of the phosphoric acid.

- ▶ If necessary, pull the plug-in couplings off the APE acid dosing unit.
- ▶ Plug the plug-in couplings back into the acid dosing unit APE.
- ▶ Repeat the process several times

4 Operation

4.1. Commissioning

The analyser leaves the factory assembled and ready for use.

- ▶ Check the analyser regarding completeness and integrity.
- ▶ Connect the analyser to the mains.
 - ⇒ The analyser switches on.
 - ⇒ The operating system boots.
 - ⇒ Blue LEDs for ON and power supply are switched on. (In the event of an error, the Power LED lights red)
 - ⇒ The device runs through a start routine of 60 minutes. The start routine includes:
 - self-test
 - warm-up of the NDIR bench
 - cool down of the double stage gas cooler, indicated by the symbol 
 - Zeroing, indicated by symbol. 
 - The remaining time until the end of zeroing is displayed.
 - Ready for operation after 60min

4.2. Operating panel

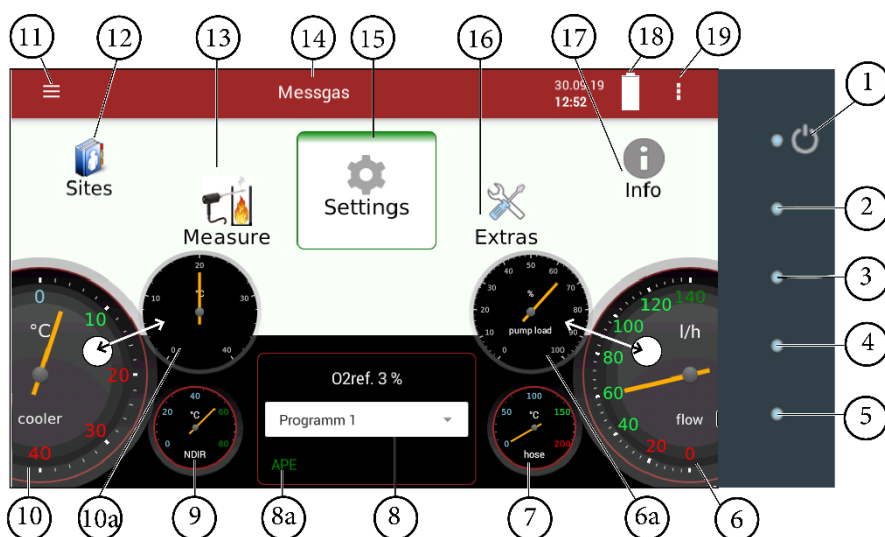

All functions are controlled via the touch surface of the instrument. Different gestures are available in the individual menus and windows.

1	Power-on / off	2	not used
3	not used	4	LED display mains operation/battery charging mode
5	not used	6	Current flow rate
6a	Current pump load	7	Current temperatures heated hose
8	Selected measuring program, e.g., Test or measurement program	8a	APE
9	Current temperatures of NDIR bench	10	Current temperatures of gas cooler 1
10a	Current temperatures of gas cooler 2	11	Access to detailed information on the instrument components. Especially for service or inquiry
12	Menu Sites	13	Menu Measure
14	Status bar: display of zero point, alarms, executed measuring program, selected fuel, heat-up-, cool-down phase	15	Menu Settings
16	Menu Extras	17	Menu Info
18	Battery Charge indicator	19	Context menu with window-dependent additional functions

**NOTE**

For display reasons, the Service menu is missing from the description of the operating panel.

4.3. Charging the battery

The analyser has an integrated rechargeable battery.

- ▶ Connect the mains plug.
 - ⇒ The battery will be charged as soon as it is connected to the mains.
 - ⇒ The blue LED (4) lights up.
- ▶ Charge battery for more than 8h is recommended after first start to allow the battery to charge completely.

NOTE

Note that the analyser can only be used in battery operation to a limited extent.

- ▶ Do not carry out any measurements in battery mode.
- ▶ Carry out only data processing and setting work in battery operation.

4.4. Switching on the analyser

- ▶ Touch the ψ button (1) for 3 sec. minimum
 - ⇒ LED lights blue
- ▶ Release the ψ button (1).
 - ⇒ Analyser runs up.

4.5. Switching off the analyser

There are two possibilities to switch off the analyser.

- ▶ Touch the Context menu (19) on the display.
 - ⇒ A selection list appears.
- ▶ Touch „Turn unit off“.
 - ⇒ A message appears.
- ▶ Touch „YES“.
 - ⇒ The analyser shuts down.

Alternatively, you can switch off the analyser as follows:

- ▶ Touch the ψ button (1).
 - ⇒ A window appears.
- ▶ Touch „YES“.
 - ⇒ The analyser shuts down.

4.6. Turn Display

- ▶ Touch the Context menu (19) on the display.
 - ⇒ A selection list appears.
- ▶ Touch Display settings.
 - ⇒ A window appears.

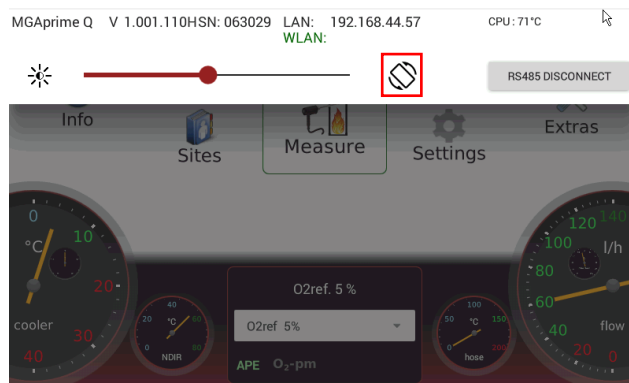

- ▶ Touch 
 - ⇒ The display turns.

4.7. Set the analyser to standby mode

The analyser is protected in standby mode. You cannot take measurements in standby mode.

The actuators, for example pumps and gas coolers, are switched off as far as possible. Note that NDIR is not switched off. After you have left the standby mode, the analyser will start up again.

The analyser will display a message that a zeroing may be useful.

- ▶ Touch the Context menu (19) on the display.
 - ⇒ A selection list appears.
- ▶ Touch Standby.
 - ⇒ A message appears.
- ▶ Press Yes to activate standby mode.
 - ⇒ The sensors are purged.
 - ⇒ The analyser is set to standby mode.

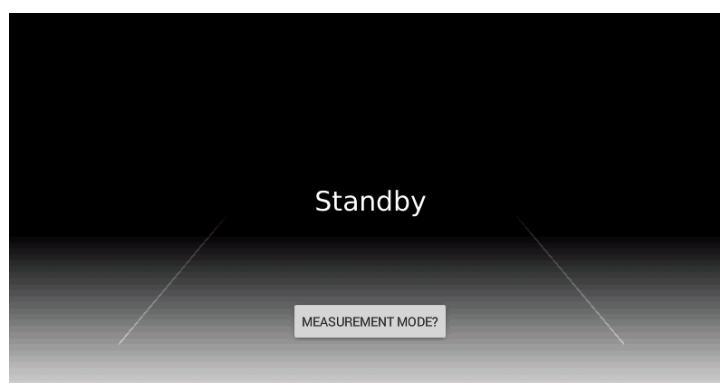

- ▶ Press MEASUREMENT MODE? to restart the analyser.
 - ⇒ A message appears.
- ▶ Press Yes to exit the standby mode.
 - ⇒ A message appears.

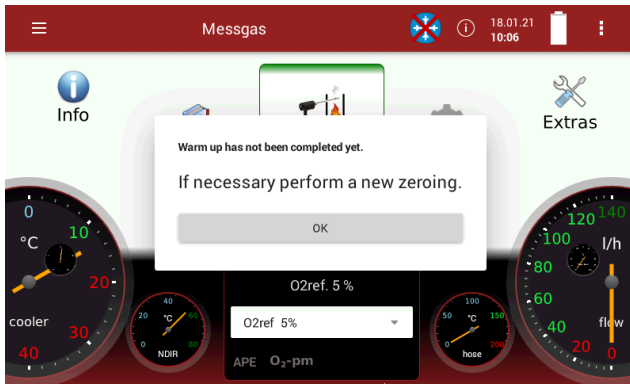

- ▶ Press OK.
 - ⇒ The analyser is heated up.
- ▶ If necessary, perform a new zeroing.

4.8. Back to homescreen / Back to measure

As soon as the back button is displayed, you have the option to go back to the homescreen or go back to the measurement, from any window.

- ▶ Press for one second 
 - ⇒ A selection list appears.

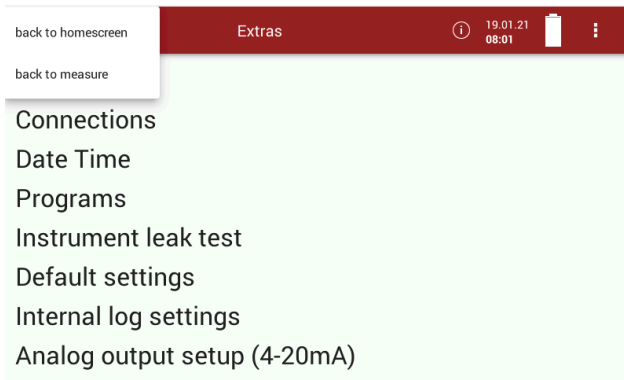

- ▶ Select if you want to go back to the homescreen or to measure.

4.9. Create screenshots

You can create screenshots and save them on a USB-Stick.

- ▶ Insert a USB-Stick into the analyser.
- ▶ Touch the button 2 and button 3 simultaneously for 3 seconds.
 - ☞ See also chapter 4.2 Operating panel, page 19.
 - ⇒ A folder "Screenshots" is created on the USB-Stick.
 - ⇒ The screenshot is saved as PNG in the "Screenshots" folder.

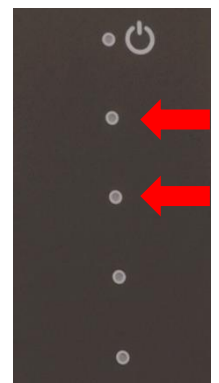

5 Settings

After the analyser has been inspected and is ready for start-up it can be switched on and personalized settings can be entered. These settings can be changed at any time.

5.1. Open menu Settings

► Press Settings

⇒ A list appears.

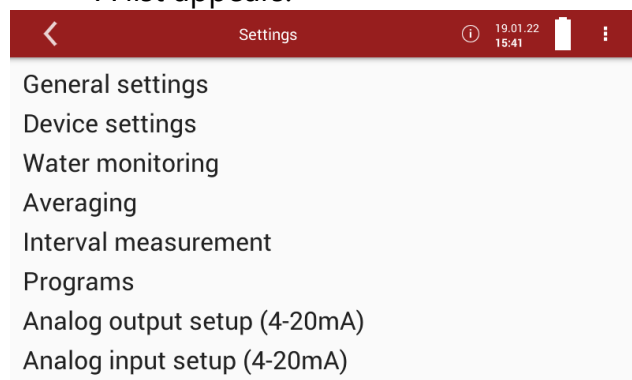

► Select the desired menu item.

5.2. General settings

► Open the menu Settings.

☞ See also Chapter 5.1 Open menu Settings, Page 24.

► Press General settings.

⇒ A window appears.

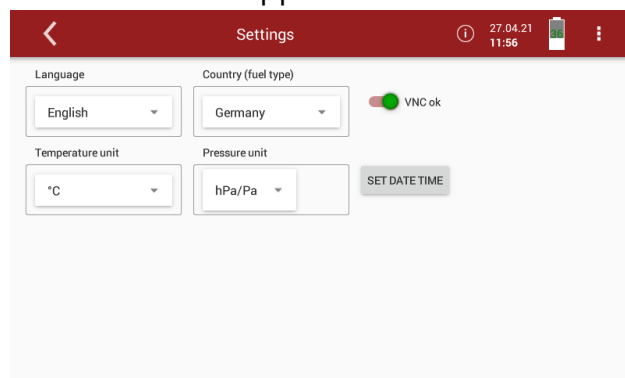

In the menu General settings, you can make the following adjustments:

Setting	Range	Description
Language		Select analyser language
Country (fuel type)		By changing the country, the O ₂ reference values settings are lost. The fuel list is reset. Similarly, country-specific defaults and methods of measurement are selected as a result. Ensure the correct setting of the country in which you are performing the measurement to ensure that all relevant ones are set up
Temperature unit	°C, °F	Change of unit
Pressure unit		Change of unit
VNC	ON / OFF	VNC Viewer for remote control
Set Date Time		☞ See also Chapter 5.3 Setting Date and Time, Page 25.

- ▶ Select the desired setting.
- ▶ Change the desired setting.
- ▶ Exit the menu „Settings“.
- ⇒ The change will be saved.³

5.3. Setting Date and Time

- ▶ Open the menu Settings.
- ☞ See also Chapter 5.1 Open menu Settings, Page 24.
- ▶ Press General settings.
- ⇒ A window appears.

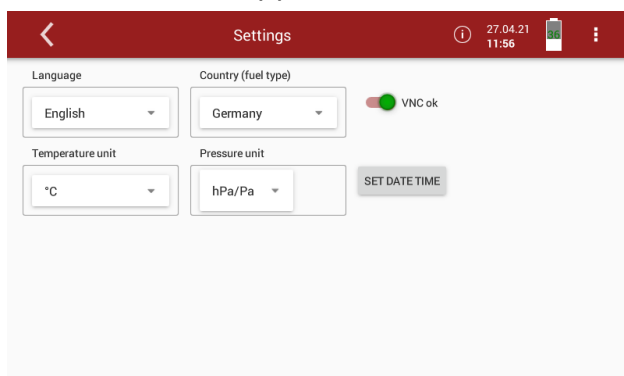

³ For the conditions that existed during the proof according to 15267-4, see also chapter 2.1 Intended use, Page 8.

- ▶ Press SET DATE TIME
- ⇒ A window appears.

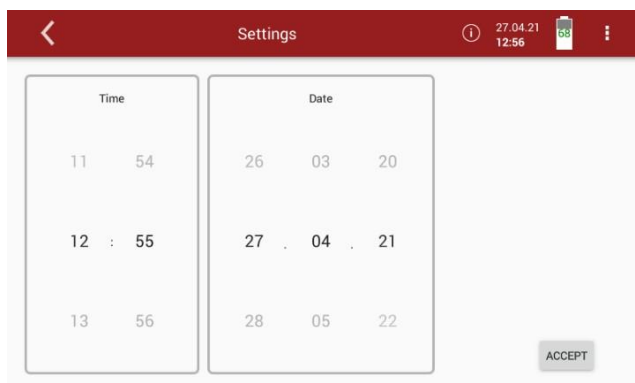

- ▶ Set the desired time and date.
- ▶ Press ACCEPT.
- ⇒ The set time and date are shown in the display.

NOTE

Note that the time setting is limited to +/- 14 hours.

- ⇒ The analyser displays a corresponding message.
- ▶ Select a valid date.

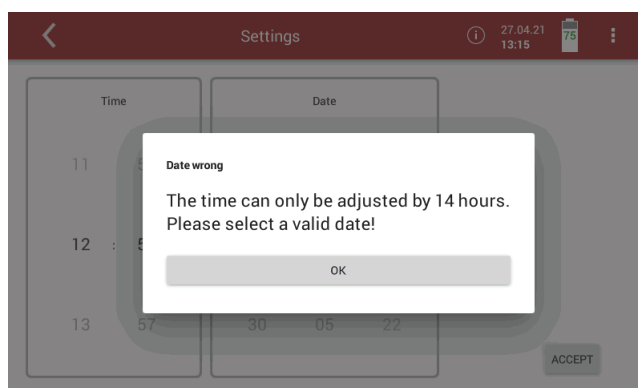

5.4. Device settings

► Open the menu Settings.

☞ See also Chapter 5.1 Open menu Settings, Page 24.

► Press Device settings.

⇒ A window appears.

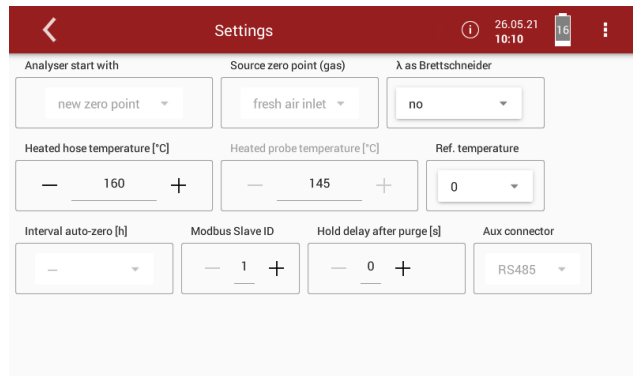

In the menu Device settings, you can make the following adjustments

Setting	Range	Description
Analyser start with		This setting must be unlocked first. For an overview on all available options please refer to the company's home page or sales representatives.
Source zero point (gas)		Not available for MGAprime-Q
λ accor. Brettschneider	ON / OFF	Calculation of the combustion air ratio (λ Lambda) according to "Brettschneider"
Heated hose temperature	80 – 180° C 176 – 355° F	
Heated probe temperature	120 – 180° C 250 – 355° F	
Ref. temperature		Calculation of the values for a standard state at reference temperature
Interval auto-zero [h]		See also Chapter Automatic zero point, S. 60
Modus Slave ID		Modbus address of the instrument for the remote control via Modbus
Hold delay after purge		Time in which Analog outputs maintain their value after zero-point measurement
Aux connector		Intended for use with the APE acid dosing unit only.

- ▶ Select the desired setting.
- ▶ Change the desired setting.
- ▶ Exit the menu „Settings“.
- ⇒ The change will be saved.⁴

5.5. Water monitoring

The analyser measures the water concentration of the sample gas in the infrared measuring cell. A measurement of different sample gas components is particularly accurate if the water concentration in the measuring cell is as constant as possible and does not change after the zero point has been taken. Reasons for a change can be a gradual drying out of the gas cooler or subsequent components. The analyser offers with this menu item the possibility to recommend or even start a new zeroing based on the water measurement.

HINWEIS



The accuracies achieved in the proficiency test are realised without this monitoring and derived zero point taking. This monitoring is only intended for higher accuracy requirements and is deactivated in the delivery state.

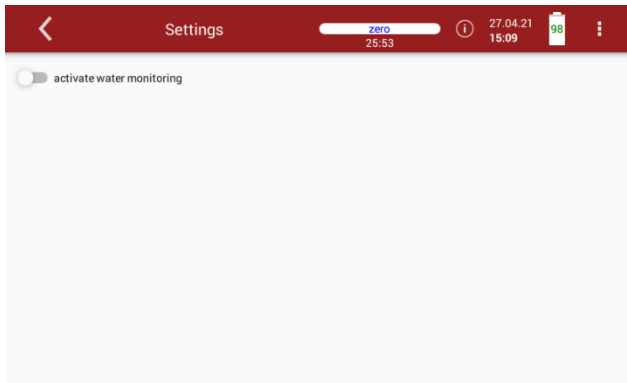

- You have the possibility to set a permitted deviation between the reference value and the current value.
 - You have the possibility to set an allowed duration of the Deviation
 - You have the possibility to set the time when the water monitoring should start after the zero point has been taken
- ▶ Open the menu Settings.
 - ☞ See also Chapter 5.1 Open menu Settings, Page 24.
 - ▶ Press Water monitoring.
 - ⇒ A window appears.
 - ▶ Activate water monitoring

⁴ For the conditions that existed during the proof according to 15267-4, see also chapter 2.1 Intended use, Page 8.

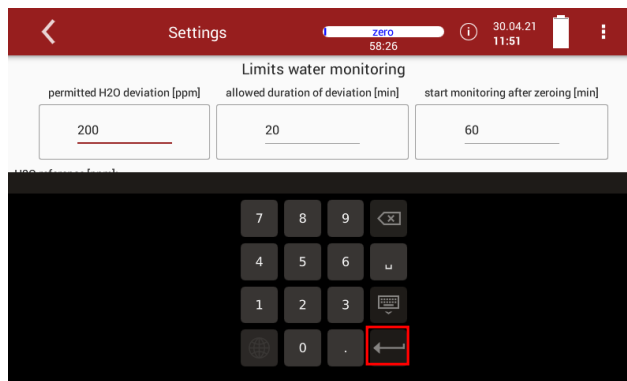

⇒ A window appears.



- ▶ Set the permitted H₂O deviation [ppm].
- ▶ Confirm the value with .
- ▶ Set the allowed duration of deviation [min].
- ▶ Confirm the value with .
- ▶ Set the time after the zero point has been taken, when water monitoring is to be started.
- ▶ Confirm the value with .
- ▶ Wait until zeroing is completed.
 - ⇒ After zeroing, H₂O reference [ppm] value is displayed.
 - ⇒ Monitoring status shows: Monitoring was initialized. Waiting time after zeroing

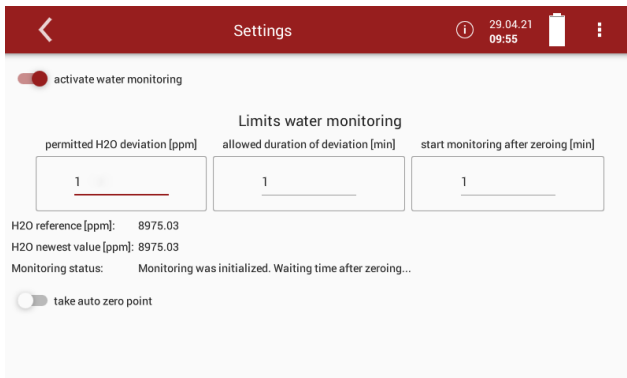

- ⇒ After the set time from start monitoring after zeroing has elapsed, monitoring starts.

Monitoring status shows: Monitoring is running

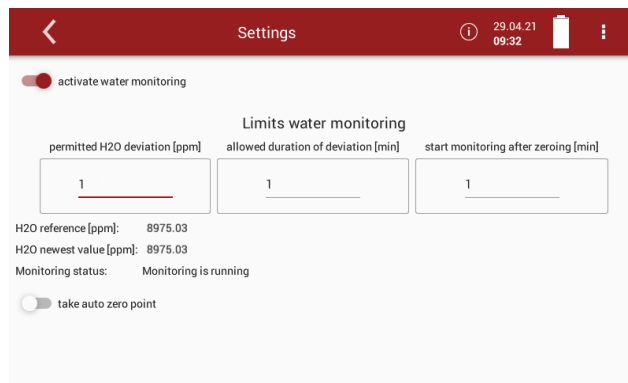

- ⇒ The analyser continuously displays the newest H₂O value [ppm].
- ⇒ As soon as the permitted H₂O deviation [ppm] is exceeded, the status changes to: Overrun was detected.

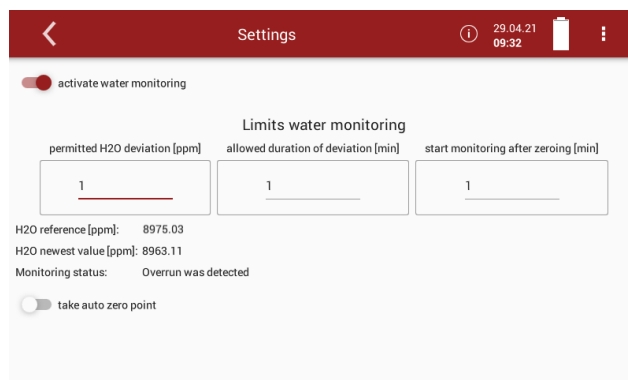

- ⇒ If the allowed duration of deviation [min] is exceeded, the status changes to: A second overrun during the allowed duration of deviation was detected. Perform new zeroing!
- ⇒ A message appears.

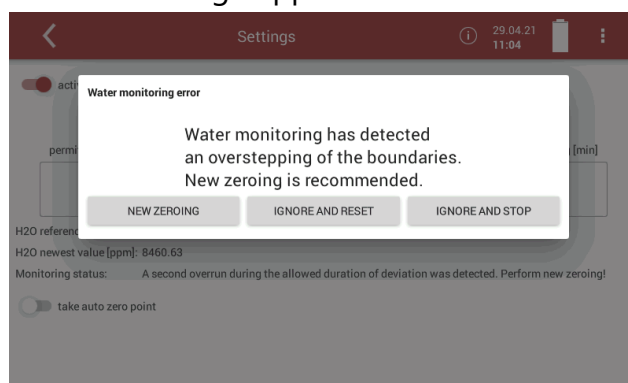

- ▶ You have the possibility to perform a new zeroing.
- ▶ You have the possibility to ignore the message and reset the water monitoring. The water monitoring starts again.
- ▶ You have the possibility to ignore the message and stop the water monitoring.

You can also set, that a zero point is taken automatically

- ▶ Activate take auto zero point.

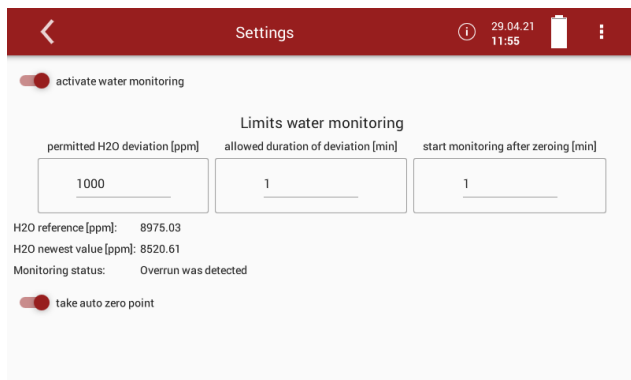

⇒ After a second overrun was detected, zeroing starts automatically.

5.6. Averaging

You can set that a permanent averaging is performed.

- ▶ Open the menu Settings.

☞ See also Chapter 5.1 Open menu Settings, Page 24.

- ▶ Press Averaging.

⇒ A window appears.

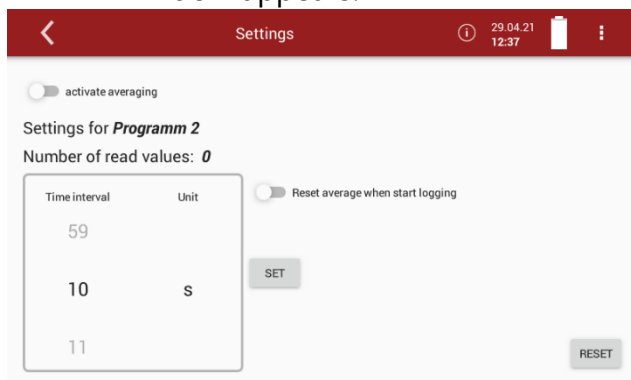

- ▶ Set the desired Time unit. You can choose between

- ▶ minutes and seconds.

- ▶ Set the desired Time interval

- ▶ Press SET

⇒ The averaging starts.

⇒ The number of read values is counted up according to the set time interval.

⇒ As soon as the set time interval is reached, the number of read values remains constant.

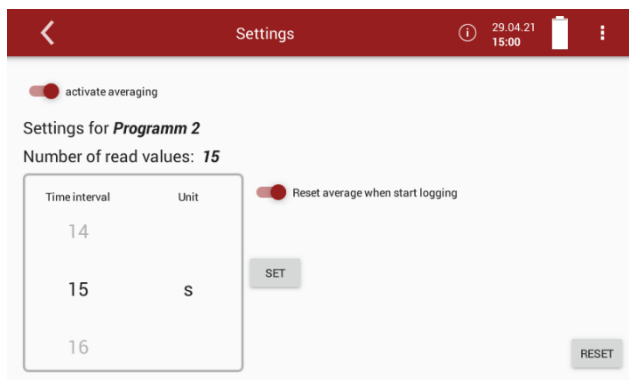

You can set that at the start of an Auto-measurement (logging) the average values are reset.

► Activate Reset average when start logging.

NOTE



Note that average values are only exported for single measurements (from a certain point in time) in a CSV export. Average values can be displayed in an Auto-measurement to check a measurement for plausibility.

If averaging is activated, the average values are displayed in the measurement window.

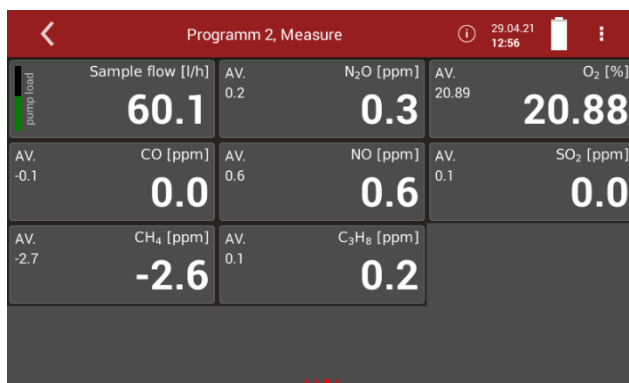

NOTE



Please note that average values are displayed immediately in the measurement window, even if the set time interval has not yet been reached. The average value is then calculated from the values read so far. As soon as the set time interval has been reached, the average value is constantly recalculated by replacing the last value read with the currently read value.

5.7. Interval measurement

You have the possibility to perform an Interval measurement. You can set the duration of the Measurement time, the duration of the Standby time and the amount of the Measurement cycles. The analyser will go into standby mode between intervals.

- ▶ Open the menu Settings.

☞ See also Chapter 5.1 Open menu Settings, Page 24.

- ▶ Press Interval measurements

☞ A window appears.

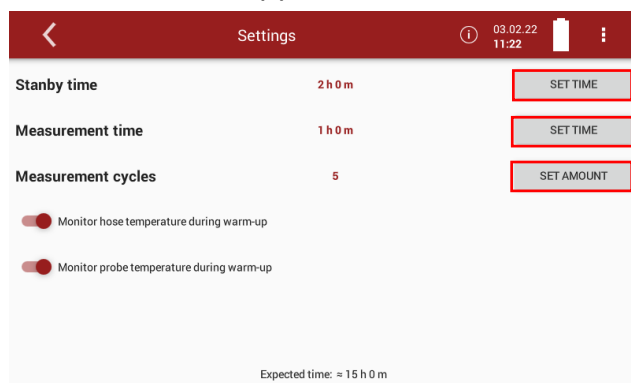

- ▶ Press SET TIME / SET AMOUNT to set the duration of the Standby time, the duration of the Measurement time and the amount of Measurement cycles.

☞ A separate input window appears for each setting.

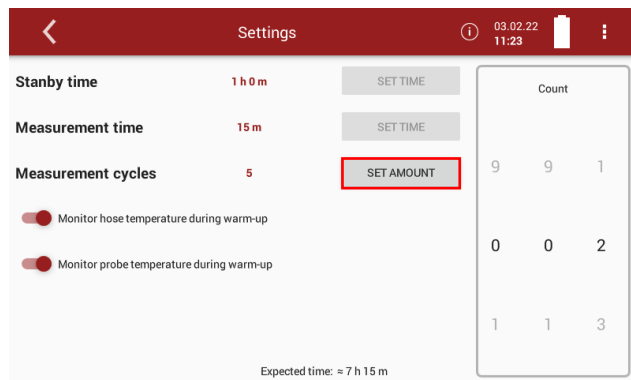

- ▶ Set the duration of the Standby time, the duration of the Measurement time and the amount of Measurement cycles.
- ▶ Press TAKE TIME OVER / SET AMOUNT.
 - ☞ The set time/amount is taken over.
 - ☞ The expected time is adjusted.

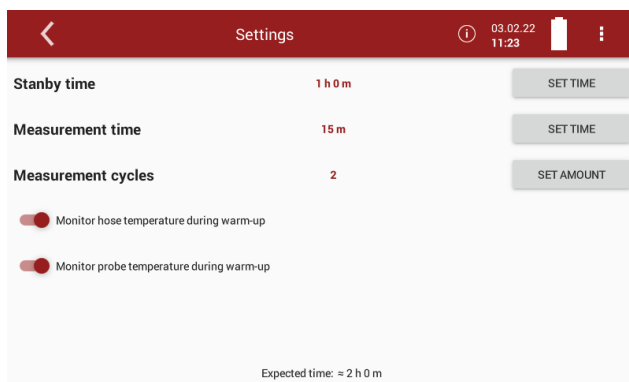

- ▶ Activate / deactivate whether the heated hose temperature should be monitored during heating.
- ▶ Activate / deactivate whether the probe temperature should be monitored during heating.
- ▶ Go to the menu Measure.
- ▶ Press the Context menu
 - ⇒ A selection list appears.

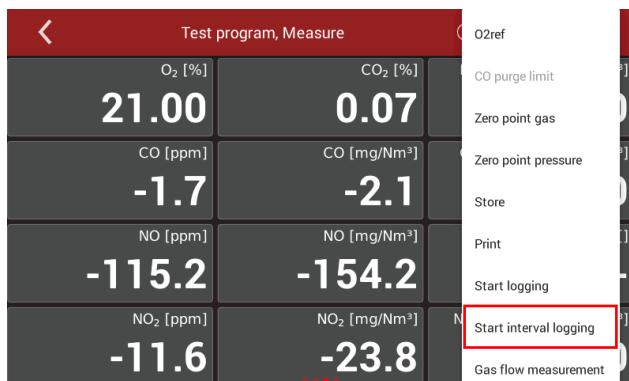

- ▶ Press Start interval logging.
 - ⇒ A window appears.

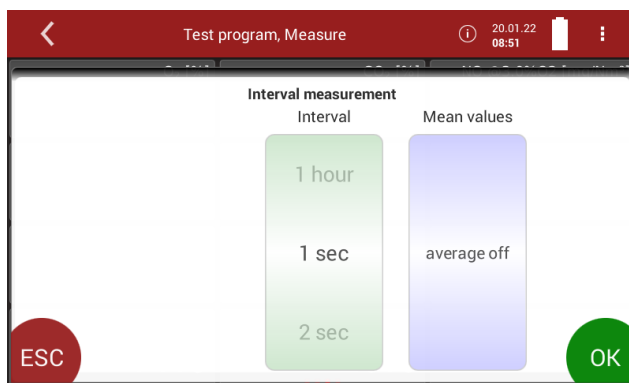

- ▶ Set the desired interval.
- ▶ Set whether Mean values should be calculated.
- ▶ Press OK.
 - ⇒ The menu Please select site appears.
 - ⇒ The following icon appears in the display 

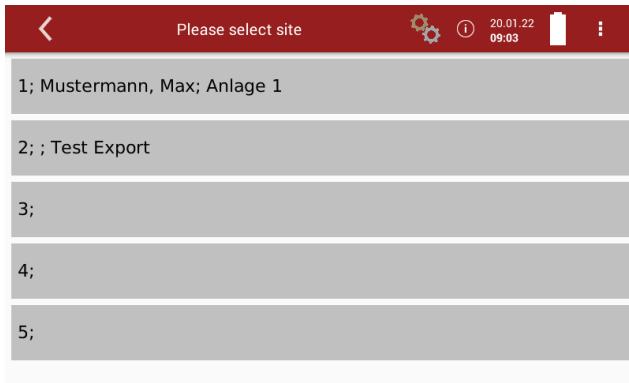

- ▶ Select the desired site.
 - ⇒ The measuring window appears.
- ▶ Press 
 - ⇒ A window appears.

NOTE

i

To stop displaying the window, press the  button again.

- ⇒ Information on the remaining time of the measurement and the remaining measurement cycles is displayed.

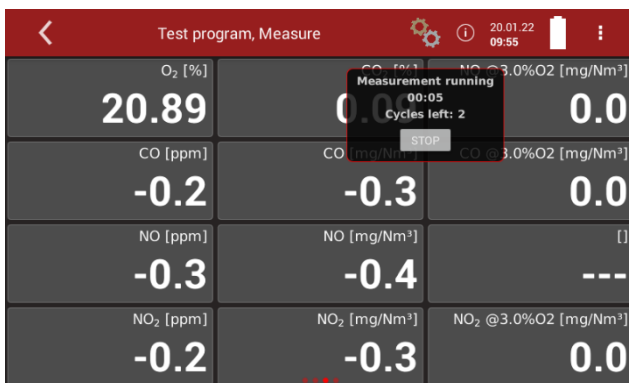

- ⇒ After the set measurement time has been completed, a flushing process is initiated.

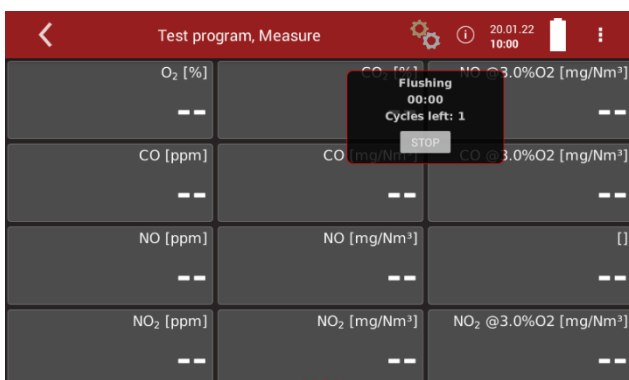

- ⇒ After the flushing process, the analyser is put into standby mode.
- ⇒ The remaining standby/wait time is displayed.

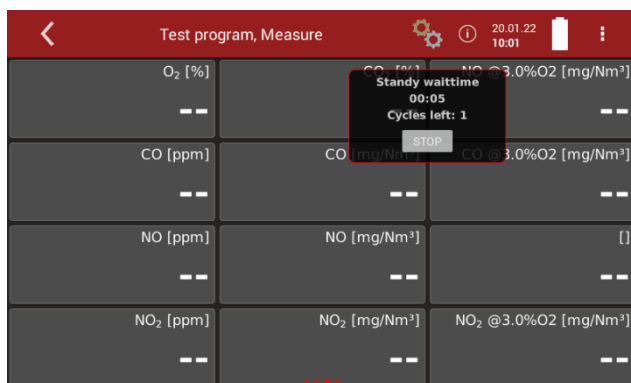

- ⇒ After the set standby time has elapsed, a warm-up phase is initiated.

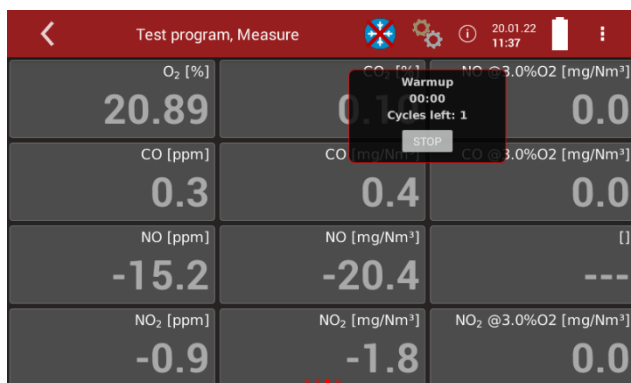

- ⇒ After the warm-up phase has elapsed, a zeroing is initiated.



- ⇒ After taking the zero point, another measurement is started
- ⇒ The process repeats itself according to the set amount of measurement cycles.

5.8. Programs

You can change the Program names.

- ▶ Open the menu Settings.

☞ See also Chapter 5.1 Open menu Settings, Page 24.

- ▶ Press Programs.

⇒ A window appears.

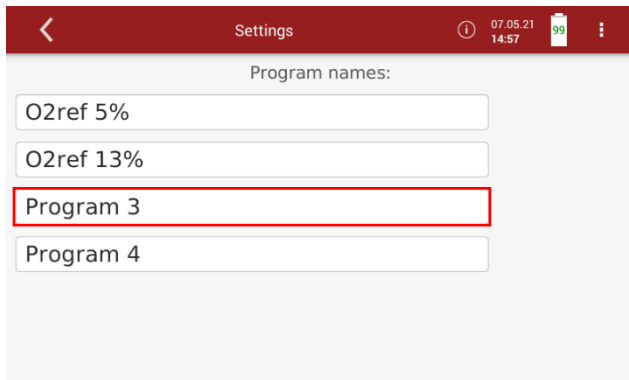

- ▶ Select the program you want to change the name for.

⇒ A keybar appears.

- ▶ Enter the desired Program name.

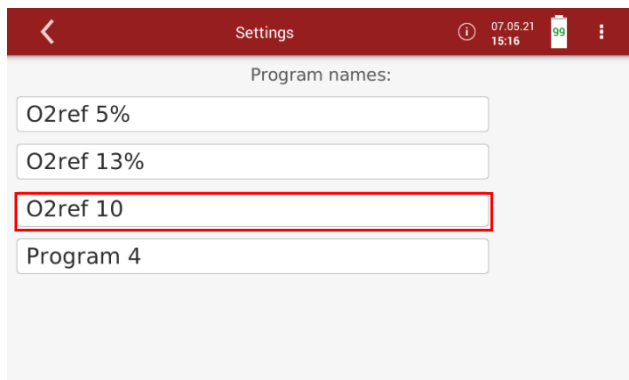

- ▶ Exit the menu

- ▶ Press Selected measuring program.

☞ See also Chapter 4.2 Operating panel, Page 19.

⇒ The changed program name is shown in the display.

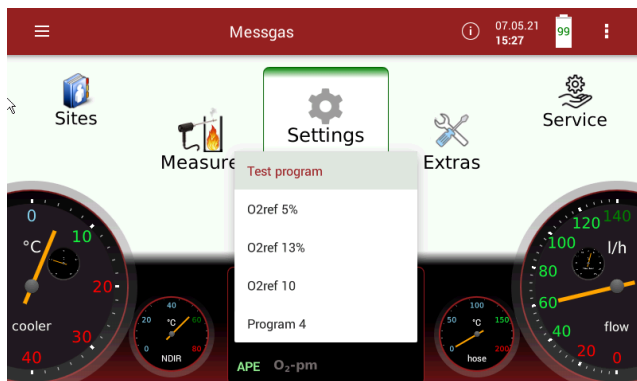

5.9. Analog output setup (4-20mA)

There are 8 Analog outputs (4-20 mA) available.
Each Analog output (channel) is assigned a measured variable and an output range.

Setting channel

- ▶ Open the menu Settings.
 - ☞ See also Chapter 5.1 Open menu Settings, Page 24.
- ▶ Press Analog output setup (4-20mA).
 - ☞ A window appears.

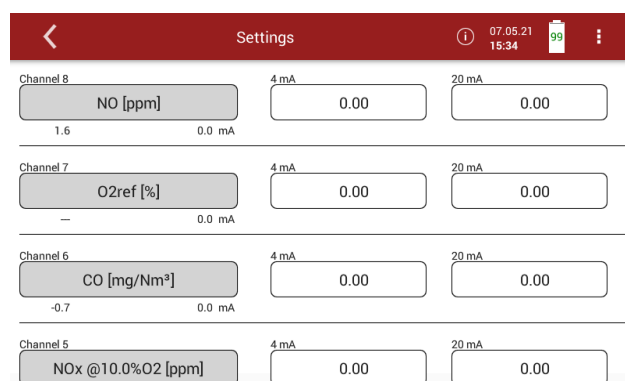

- ▶ Choose the desired channel.
 - ☞ A selection list appears.

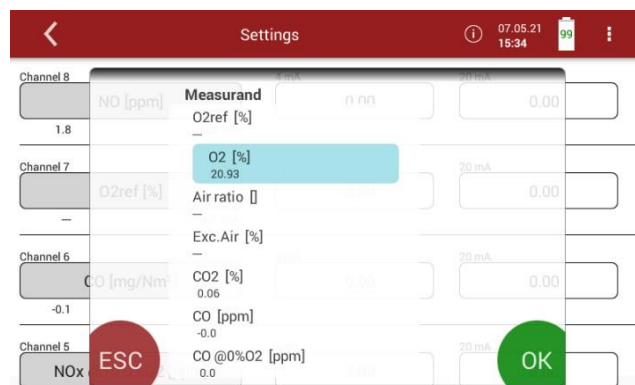

- ▶ Choose the desired measurand.
- ▶ Press OK.
 - ☞ The measurand is assigned to the desired channel.

Setting lower / higher limit**NOTE****Setting lower limit (4mA)**

This setting determines the lower end value, corresponding to 4 mA. If the measured value falls below the set value, the Analog output stops at 4 mA.

HINWEIS**Setting higher limit (20mA)**

This setting determines the higher end value, corresponding to 20 mA. If the measured value rises above the set value, the value remains at 20 mA.

- ▶ Open the menu Settings.
 - ☞ See also Chapter 5.1 Open menu Settings, Page 24.
- ▶ Press Analog output setup (4-20mA).
 - ⇒ A window appears.
- ▶ Press the 4 mA or 20 mA field to set the limits for a specific channel.
 - ⇒ A window appears.

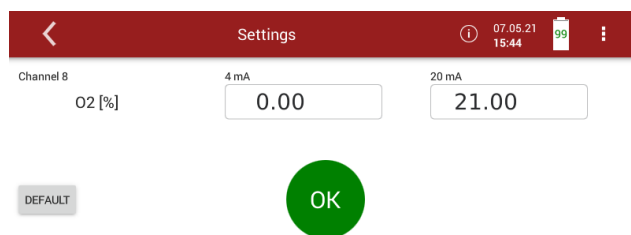

- ▶ Enter the desired values for the lower and higher limit.
- ▶ Press OK.
- ▶ Press "Default" to set the default values for the lower and upper limits.
 - ⇒ The lower and higher limit are assigned to the desired channel.

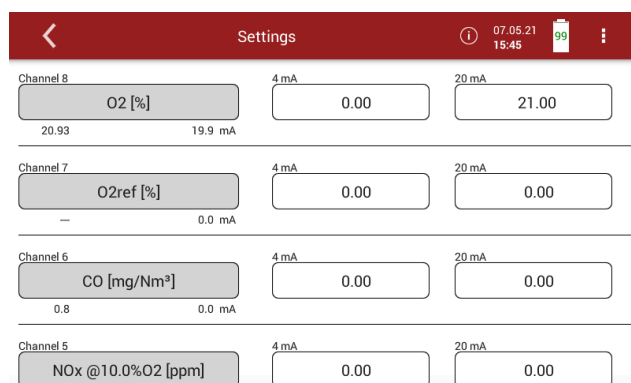

Setting Analog outputs during zeroing

Zeroing starts automatically. The display shows „zero“. The remaining time until the Zero point measurement ends is displayed.



The following settings are possible:

- Hold - The outputs kept the last values from before zeroing
- 2 mA - The outputs change to 2 mA to indicate the zero point

► Open the menu Settings.

☞ See also Chapter 5.1 Open menu Settings, Page 24.

► Press „Analog output setup (4-20mA)“.

⇒ A window appears.

► Scroll to "Output during zeroing"

► Press the field.

► Choose the desired option.

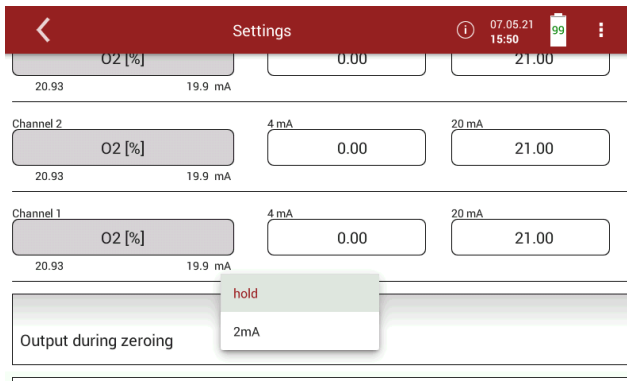

Pin assignment of the 4-20mA interface (Analog IN / OUT)

- ▶ Open the menu Settings.
 - ☞ See also Chapter 5.1 Open menu Settings, Page 24.
- ▶ Press „Analog output setup (4-20mA)“.
 - ⇒ A window appears.
- ▶ Press „Analog output setup (4-20mA)“.
 - ⇒ A window appears.
- ▶ Scroll to graphic representation of the pin assignment of the 4-20 mA interface.

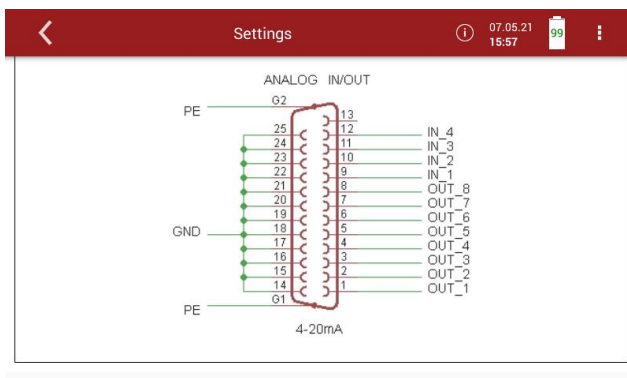

⇒ The setting is saved

5.10. Analog input setup (4-20mA)

There are 4 Analog inputs (4-20 mA) available. Each Analog input (channel) is assigned a measured variable and an output range.

► Open the menu Settings.

☞ See also Chapter 5.1 Open menu Settings, Page 24.

► Press Analog input setup (4-20mA).

⇒ A window appears.

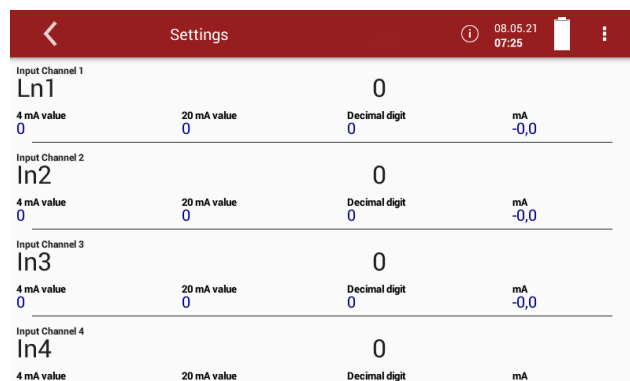

► Choose the desired channel.

⇒ A window appears.

► Enter the desired values.

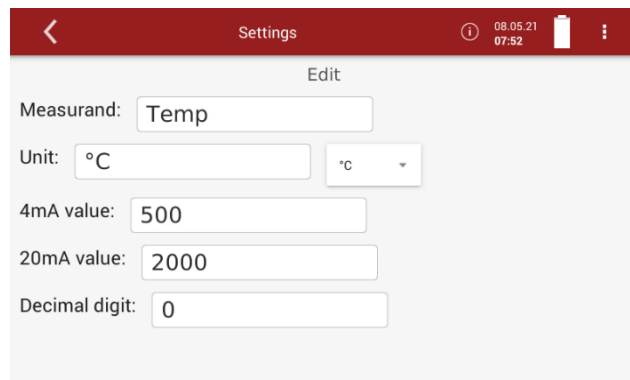

► Go back.

⇒ The values appear in the selection list.

⇒ The incoming measurand is displayed.

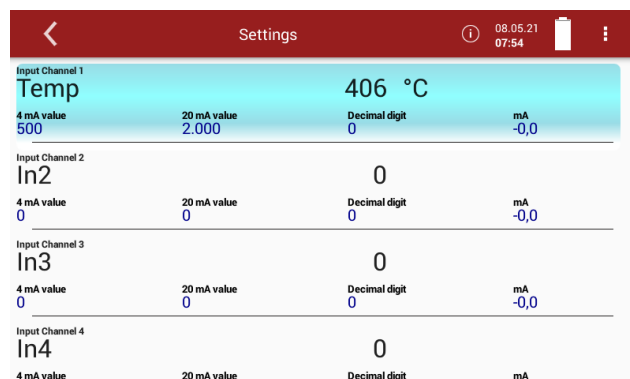

5.11. Connecting analyser with WIFI (WLAN)

- ▶ Insert a WLAN-Stick into the Analyser.
- ▶ Open the menu Settings.
 - ☞ See also Chapter 5.1 Open menu Settings, Page 24.
- ▶ Press WIFI.
 - ☞ A window appears.
- ▶ Switch on the WLAN.
 - ⇒ The available WLAN connections are displayed.



NOTE

Press the button REFRESH, if no WLAN connection is displayed

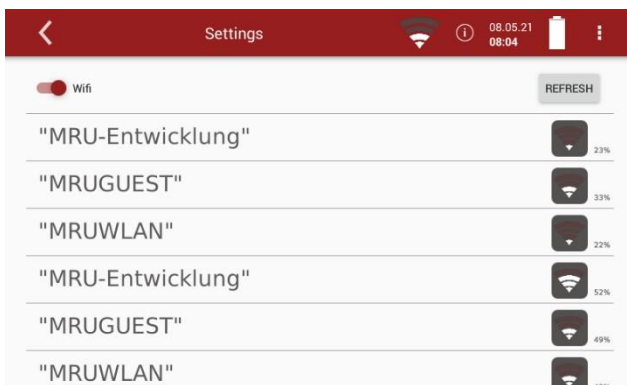

- ▶ Select the desired WLAN-Connection.
 - ⇒ A window appears.
- ▶ Enter the WLAN password.

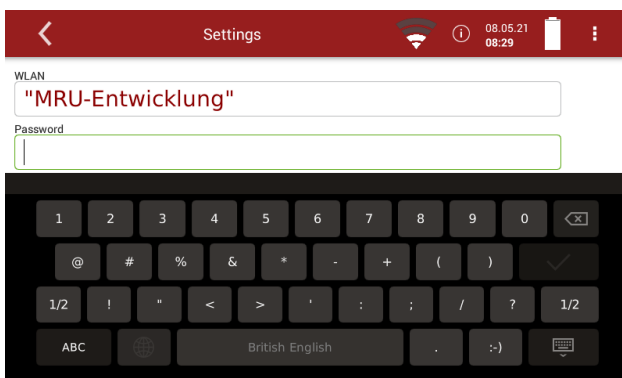

- ▶ Press „OK“.

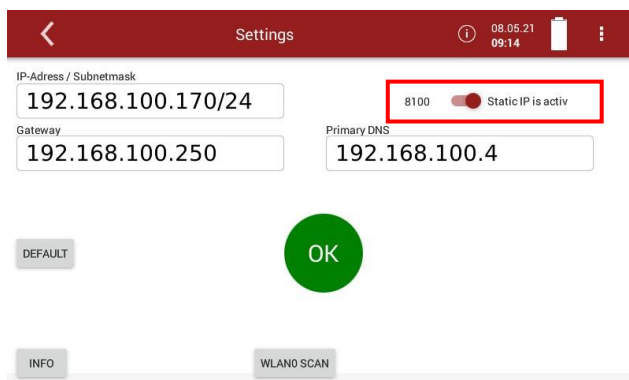

- ⇒ A connection to the WLAN network is established.
- ⇒ A WLAN symbol appears in the display.
- ▶ Touch the WLAN icon to see the WLAN IP.
- ▶ Alternatively, press the context menu button to display the WLAN IP.



- ▶ Use the displayed WLAN -IP for MRU4win (in this example 192.168.43.53).
- ☞ See also Chapter 18.4 Connecting analyser with MRU4win, Page 127.

5.12. Getting information about the network

- ▶ Open the menu Settings.
 - ☞ See also Chapter 5.1 Open menu Settings, Page 24.
- ▶ Press Network.
 - ⇒ A window appears.

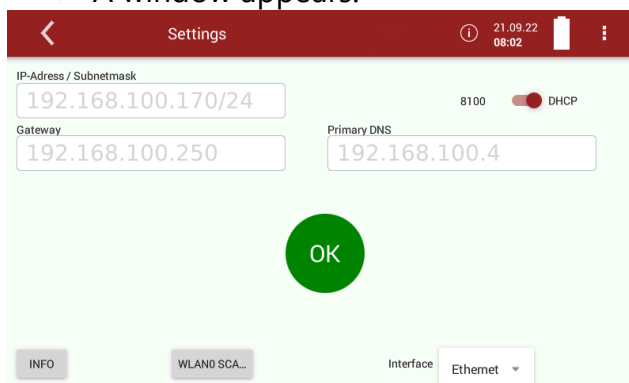

- ▶ Press INFO
 - ⇒ Information about the network appear.

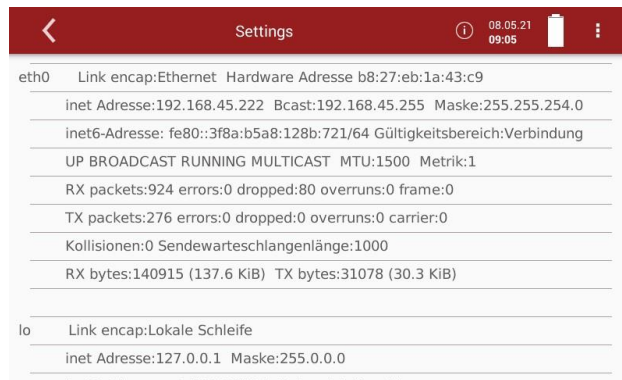

5.13. Assigning a static IP address

You have the possibility to assign a static IP address via Ethernet or WLAN.

- ▶ Open the menu Settings.

☞ See also Chapter 5.1 Open menu Settings, Page 24.

- ▶ Press Network

⇒ A window appears.

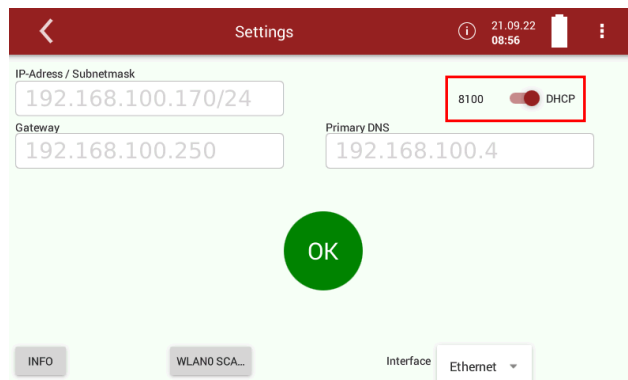

NOTE



If the switch is set to DHCP, the input fields IP address/subnet mask/gateway and Primary DNS are disabled. If the switch is set to DHCP, you cannot assign a static IP address.

- ▶ Set the switch to "Static IP ".

⇒ The input fields for "IP address/subnet mask", "Gateway" and "Primary DNS" become enabled.

⇒ You can assign a static IP address.

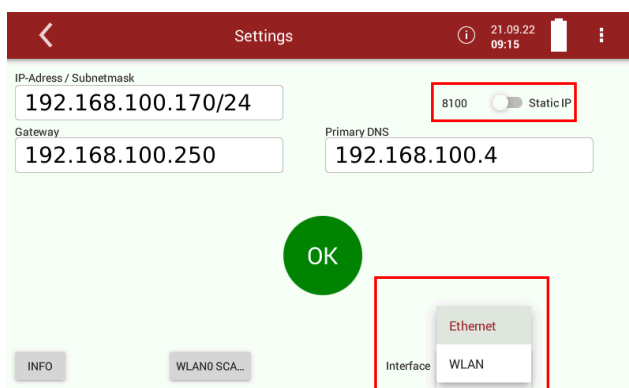

- ▶ Enter the values for "IP-Adress / Subnetmask", "Gateway" and "Primary DNS"
- ▶ Select the desired interface.
- ▶ Press „OK“.
 - ⇒ A window appears.
- ▶ Choose the desired option.
 - ⇒ The change takes effect after a restart

5.14. Serial connectivity (RS485/USB)

You have the option of transferring data wirelessly with MRU4Win to a PC/notebook.

Use the USB Bluetooth converter set (# art. no. 12992).

The USB-Bluetooth converter set consists of two pre-paired and configured converters.

The distance can be up to 300m depending on local conditions.



NOTE

Ensure that the analyser is switched off before plugging the USB Bluetooth converters into the USB port.

- ▶ Plug a USB Bluetooth converter into the USB port of the analyser.
- ▶ Switch on the analyser.
- ▶ Plug the second USB Bluetooth converter into the switched-on PC.
 - ⇒ The middle LED (Connect) should flash on both converters. The two converters are connected.
- ▶ Open the menu Settings in the analyser.
 - ☞ See also Chapter 5.1 Open menu Settings, Page 24.
- ▶ Select Serial connectivity (RS485/USB)
 - ⇒ A window appears.

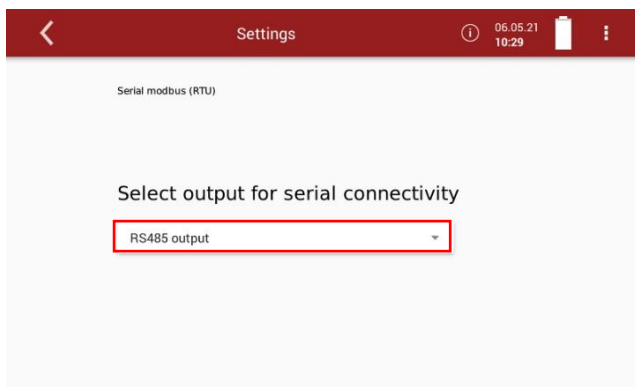

HINWEIS

Ensure that under "Settings/General" the setting "Activate Modbus" is checked.



► Select Livemeasurements.

⇒ The menu Livemeasurements appears.

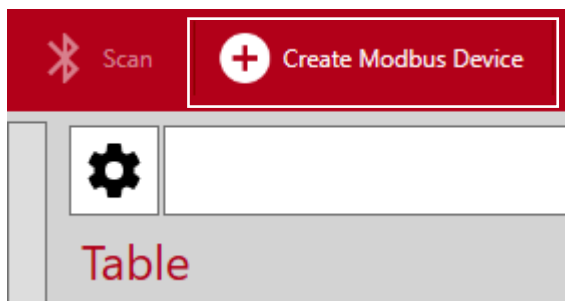

► Click Create Modbus Device.

⇒ The window Modbus Settings appears.

► Enter the following parameters:

- Device = 1113 Device
- Slave ID= Slave ID of the analyser. In this example the Slave ID is 1.
- Serial / TCP = Serial
- Comport = The converter creates a new Comport. Please enter this Comport in MRU4Win.
In this example the Comport is Com 3. You can find more information in the MS Windows Device Manager.
- Baud rate = 19200
- Data Bits = 8
- Parity = Even
- StopBits = One

- ▶ Click OK.
 - ⇒ The Modbus Device is created.

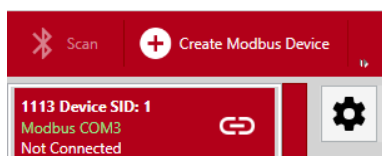

- ▶ Click 
 - ⇒ The connection is established.

5.15. Default settings

You can reset the analyser to factory default.



NOTE

Note that when the analyser is reset to factory default all individual settings are lost.

- ▶ Open the menu Settings.
 - ☞ See also Chapter 5.1 Open menu Settings, Page 24.
- ▶ Press Default settings
 - ☞ A window appears.

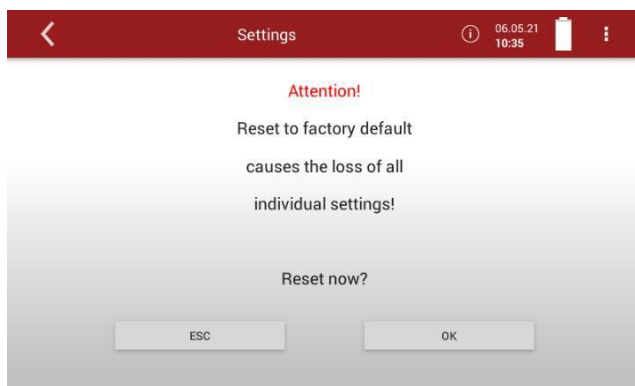

► Press OK.

⇒ The analyser is reset to factory default

5.16. Configuration of measurement program

The Analyser provides in the Measure menu various measurement programs, which can be selected in the main window. Each measuring program defines the properties of the measuring window:⁵

Test program

The measured value window shows predefined values and cannot be changed. Can be used in instrument testing to obtain standardized displays, e.g. can easily be checked with test gases.

Measurement program

The measured value window can be freely set with regard to the displayed measured values.

⁵ Conversions and references are not part of the proof according to 15267-4. See also Chapter 2.1 Intended use, Page 8.

Further measuring programs

The measurement window for gas analysis can be configured and adapted to your needs. The measuring window initially displays 12 measured values, by a scrolling gesture it will display more values.

Moving a value field

- ▶ Touch the menu Measure
 - ⇒ The measurement window appears.

Programm 1, Natural gas			10/01/19 09:56
O2 [%]	CO @0%O2 [ppm]	NO2 [mg/Nm ³]	
20.91	0.0	-0.1	
NO2 [ppm]	NOx @0%O2 [ppm]	NOx @3.0%O2 [ppm]	
-0.0	0.0	0.0	
CO2 [%]	CH4 [mg/Nm ³]	CO @0%O2 [ppm]	
0.07	-0.9	0.0	
current pump load [%]	Sample flow [l/h]	CO [ppm]	
66	59.5	-0.1	

- ▶ Touch and hold the value field.
 - ⇒ Value field will be framed.
- ▶ Move the value field to a different position.
 - ⇒ The other value fields move automatically.

Assign a measured value

- ▶ Touch the menu Measure
 - ⇒ The measurement window appears.
- ▶ Double touch the value field.
 - ⇒ A selection list appears.
- ▶ Touch the desired measurand.

Programm 1, Natural gas			10/01/19 10:16
O2 [%]	CO @0%O2 [ppm]	NO2 [mg/Nm ³]	
20.91	0.0	0.1	
NO2 [ppm]	NOx @3.0%O2 [ppm]	NOx @3.0%O2 [ppm]	
0.0	0.0	0.0	
CO2 [%]	NO [mg/Nm ³]	CO @0%O2 [ppm]	
0.07	-0.2	0.0	
current pump load [%]	NO [g/s]	CO [ppm]	
66	0.000	0.0	
	NOx [ppm]	CO [ppm]	
	-0.1	-0.2	
	NOx @0%O2 [ppm]		
	0.0		

- ⇒ You can replace the selected value field with the selected measured value.

⇒ You can insert the selected measured value in place of the selected value field. The previously selected value field moves accordingly.

▶ Touch „replace“ or „insert“.

Setting zoom

▶ Touch the menu Measure.

⇒ The measurement window appears.

▶ Swipe left on the Touchscreen.

⇒ The measured values are displayed in the zoom display.

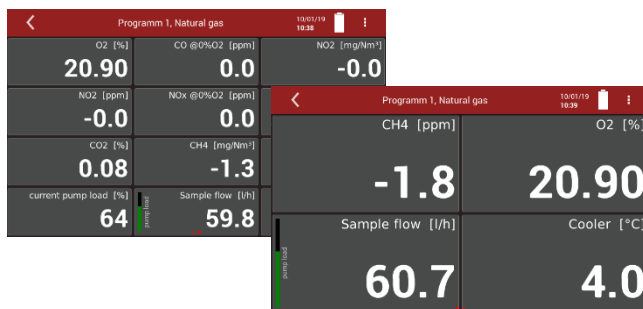

6 Measurement

6.1. Prepare measurement

⚠ CAUTION



Acid from the condensate

Acid burns may result from weakly acidic liquids from the condensate.

- ▶ If you come into contact with acid, wash the area immediately using a lot of water.
- ▶ Note the safety data sheet for phosphoric acid (10%).

⚠ DANGER



Risk due to toxic gases

There is a risk of poisoning.

Noxious gases are sucked in by the measuring device and released into the ambient air.

- ▶ Only use the measuring device in well ventilated spaces.

Operating temperature

The internal gas cooler operates at 4°C, which is the dew point of the sample gas to the sensors. Components along the gas line may be damaged if they are colder than 4°C and condensation appears internally. Therefore, if the analyser has been stored very cold below 0°C, it is essential to wait for the analyser to warm up in a warm environment in order to avoid such condensation! In such cases, take a typical warm-up time for the instrument of one hour into account, especially when wet flue gases are to be measured.

If the operating temperature is not within the permissible range, a corresponding message is displayed.

☞ See also chapter 16.6 Technical data, Page 116.

Power supply

The analyser can be operated with an internal battery to warm up the instrument or to use internal instrument functions. A mains connection is required for the measurement including heated gas sampling probe and heating hose.

ATTENTION

When measuring with coiled heated hose line, the hose line is destroyed due to strong heat development.

- ▶ Roll out the heated hose line completely for each measurement.

- ▶ Unroll the heating hose.
- ▶ Connect the heating hose.
 - ⇒ The heating hose heats up.

Opening the transport bag

- ▶ Open the transport bag to get access the control panel (1).
- ▶ Open the transport bag to get access to the left side. (2).
- ▶ Open the ventilation flap (3).

**Connections to the analyser**

☞ See also Chapter 3.4 Connectors, page 14.

- ▶ Connect the gas sampling probe to Sample gas inlet port (12) (gas coupling and round plug).
- ▶ Note that acidic condensate as well as phosphoric acid is discharged from the condensate out port (9). Consider to connect a hose or collecting container to the condensate outlet when appropriate. Ensure that the empty volume of the collection container is sufficient (24ml/h). The hose must not be closed and the collection container must have a ventilation opening.
- ▶ Please note that measuring gas may leak at the analyser side or at the Sample gas outlet port (10)

- ▶ Ensure that ambient fresh air can be sucked in at the Fresh air inlet port (11). Consider to connect a hose leading fresh air to analyser.

The flow rate of the gas should be within 60ln/h. Otherwise, please check probe and filter for clogging. Check also whether there is a device alarm.

Temperatures of NDIR and heating hose should be within the specified range in order to guarantee a sufficient measuring accuracy.

☞ See also Chapter 16 Specifications, page 114.

Plug in temperature sensor

- ▶ Plug the temperature sensor into the T-AIR connection (17).
 - ☞ See also chapter 3.4Connectors, Page14
- ▶ Open the ventilation flap and position the temperature sensor as shown below.

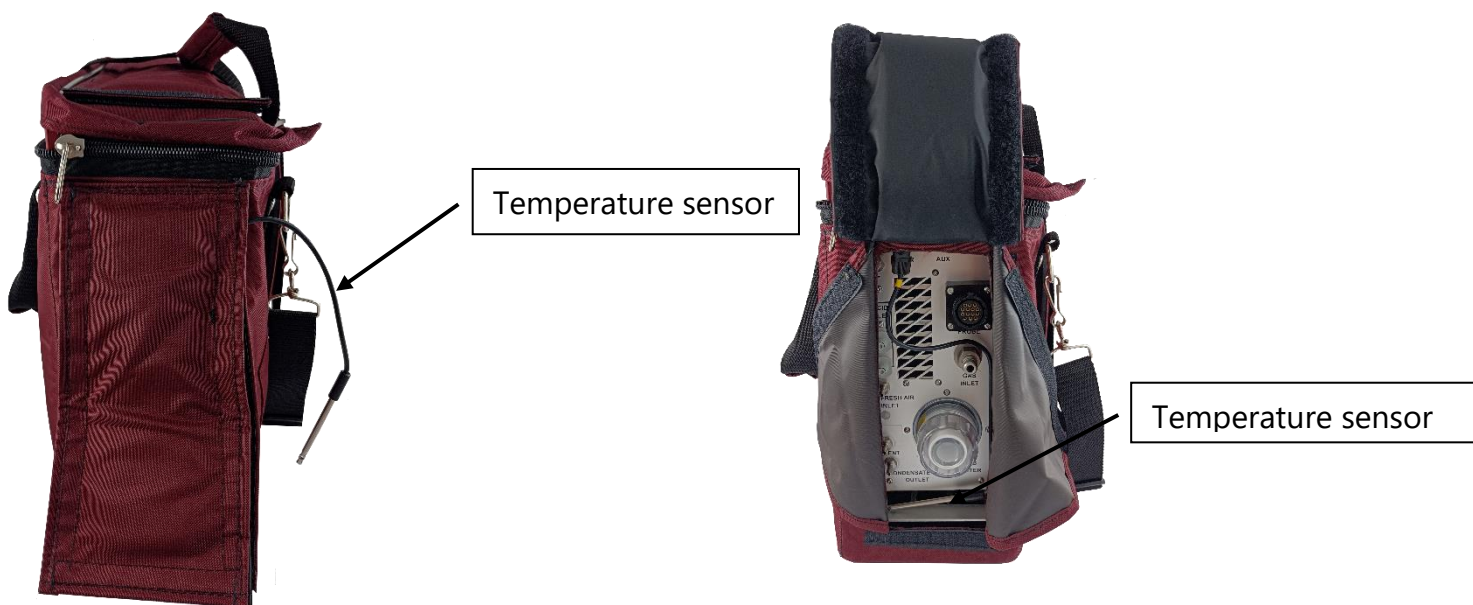

NOTE

The temperature sensor can remain plugged in permanently - even when transporting the analyser.

Switch-on, warm-up phase, zero point

After switching on, the instrument can always be operated, even if no gas analysis can take place during the warm-up phase. The instrument independently performs the following actions during the warm-up phase:

- Heating the probe and the heating hose
- Warm up the NDIR bench
- After the operating temperatures have been reached, the gas pump is switched on and the analyser takes the zero point with fresh air.
- After the zeroing, the analyser is ready for operation.
It takes one hour from the start of the analyser to the completion of zeroing.

ATTENTION

- ▶ Be sure to connect a condensate drain to the condensate outlet to avoid damage to the analyser or its surroundings.
A corresponding message is displayed when the analyser is switched on.

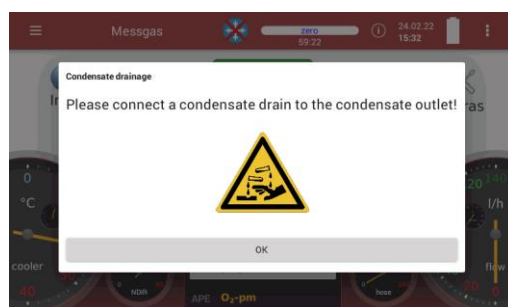

Attach clip-on filter

If you operate the analyser without a heated hose, dirt may collect in the gas inlet.

- In this case, plug the supplied clip-on filter onto the gas inlet (12).

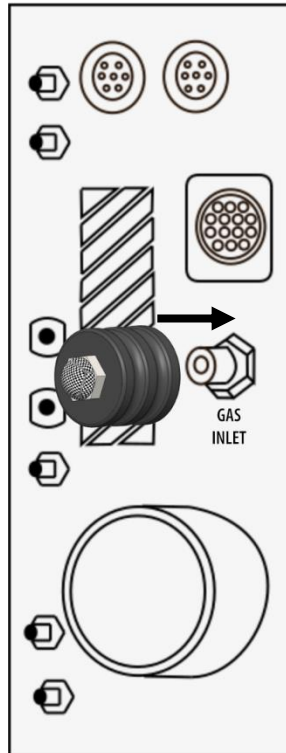

Controlling Filters

The filters (probe filter and round filter) must be checked before and after each measurement.

Connecting Acid Dosing Unit APE

☞ See also Chapter 3.9 Acid injection, page 17.

⚠ CAUTION



Acid from the condensate

Acid burns may result from weakly acidic liquids from the condensate.

- ▶ If you come into contact with acid, wash the area immediately using a lot of water.
- ▶ Note the safety data sheet for phosphoric acid (10%).
- ▶ Consider to connect a container to the condensate out port

NOTE



Phosphoric acid (10%) is not included in the scope of delivery.

Phosphoric acid (10 %) must be procured by the operator.

- ▶ Check the remaining contents of the acid tank before measurement.

- ▶ Connect a collection container to the condensate outlet.
- ▶ Plug the AUX-connector into the analyser.
The AUX-connection cable ensures that no phosphoric acid (10 %) is injected into the analyser when the pumps are switched off.
- ▶ Plug the couplings of the connecting hose into the connection nozzle of the Acid Dosing Unit APE (2x outlet to device).
- ▶ Plug the couplings of the connecting hose into the connection nozzle of the analyser.

NOTE

Always connect the collection container.
Please note that the volume of the supplied collecting container is sufficient for 2 hours of measuring operation.

- ▶ Empty the collecting container after two hours of measuring operation.
- ▶ Dispose acid condensate and phosphoric acid in accordance with national and, if necessary, local disposal guidelines.

- ▶ Plug the coupling of the connecting hose to the acid tank into the connection nozzle of the Acid Dosing Unit APE (Input 10 % phosphoric acid).

NOTE

You do not have to pay attention to any special arrangement of the couplings between the Acid Dosing Unit APE and the analyser.

Make sure that the hose connectors click into place audibly.

- ▶ Plug the cable socket of the mains cable into the Acid Dosing Unit APE (Main).
- ▶ Plug the power cord into the socket.
 - ⇒ At the end of the zero-point measurement, phosphoric acid (10 %) will be injected.
 - ⇒ The control lamp lights up green as soon as phosphoric acid (10 %) will be injected. The control of the acid dosing unit APE begins 40 minutes after the analyser is started.

NOTE

Observe the consumption of the phosphoric acid. If the consumption of the phosphoric acid decreases, there may be a defect in the supply of the phosphoric acid.

- ▶ If necessary, pull the plug-in couplings off the APE acid dosing unit.
- ▶ Plug the plug-in couplings back into the acid dosing unit APE.
- ▶ Repeat the process several times

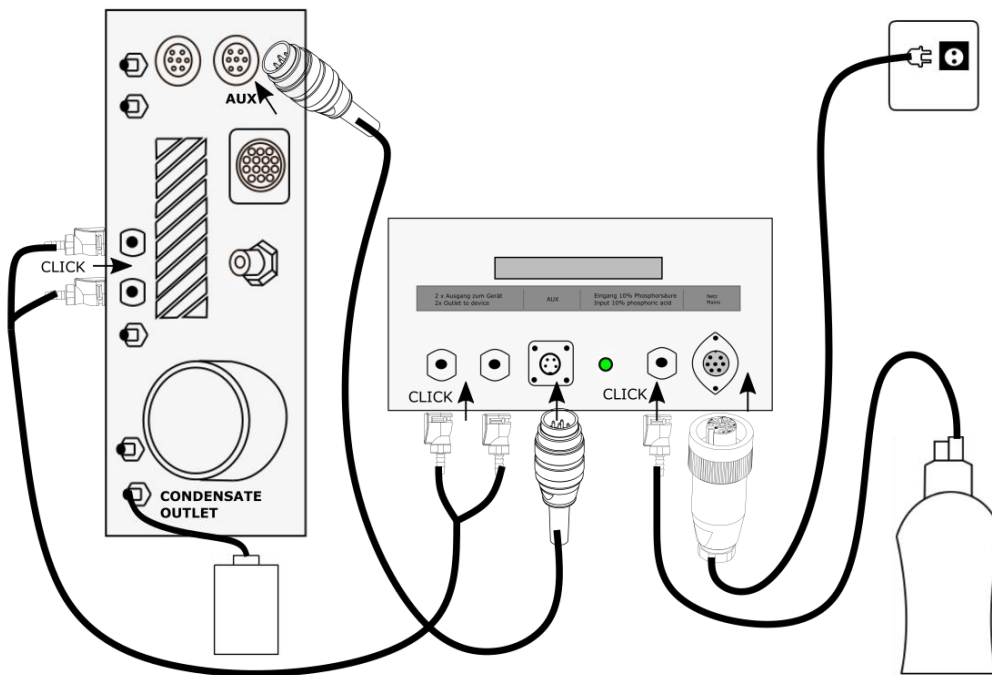

Repeated Zero point

Authorized persons can start a new zeroing after entering the pin code (Adjustment PIN).

☞ See also chapter 11 Entering Pin code, Page 95.

- ▶ Touch the menu Measure.
- ▶ Touch the Context menu.

⇒ A selection list appears.

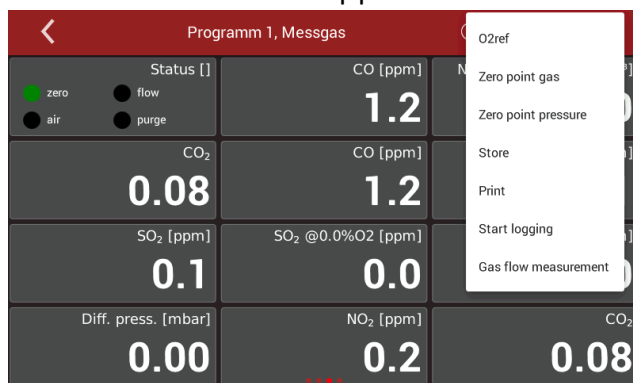

- ▶ Press Zero point gas.
- ▶ Confirm the zeroing of the gas sensors.
 - ⇒ The Zero point gas starts.
 - ⇒ The Zero point gas takes 8 minutes
 - ⇒ The Zero point gas is taken using the Fresh air inlet port (11).

Automatic zero point

Authorized users can set zero-point intervals after entering the pin code (Adjustment PIN).

☞ See also chapter 11 Entering Pin code, Page 95.

For measurements over 12 hours, it is recommended to set the zero-point interval to 12 hours. The zero-point interval can be set in pre-defined steps.



NOTE

Note that the last zero-point interval set is saved.

Charging state of the battery

The battery symbol in the display indicates approximately the remaining capacity of the battery.

From 2% remaining capacity, the charging indicator starts to flash red. If the instrument is not connected to the mains power supply within one minute, the analyser switches off to prevent battery discharge.

Even when the battery is discharged, the instrument can be operated completely on the power supply.

6.2. Take a measurement

Starting the measurement

► Touch the menu Measure.

- ⇒ The measurement window appears.
- ⇒ The measurement starts with the set parameters.

Programm 1, Natural gas			10/02/19 08:47
O ₂ [%]	CO @0%O ₂ [ppm]	NO ₂ [mg/Nm ³]	
20.93	0.0	0.5	
NO ₂ [ppm]	NO _x @0%O ₂ [ppm]	NO _x @3.0%O ₂ [ppm]	
0.2	0.0	0.0	
CO ₂ [%]	CH ₄ [mg/Nm ³]	CO @0%O ₂ [ppm]	
0.07	0.5	0.0	
current pump load [%]	Sample flow [l/h]	CO [ppm]	
66	60.0	-0.1	

Setting O₂-Reference

- ▶ Go to the menu Measure.
- ▶ Touch the "Context menu" (19).
 - ⇒ A selection list appears.

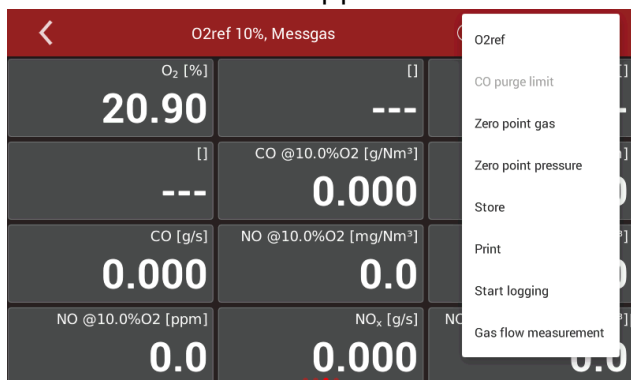

- ▶ Select O₂ref.
 - ⇒ A window appears.

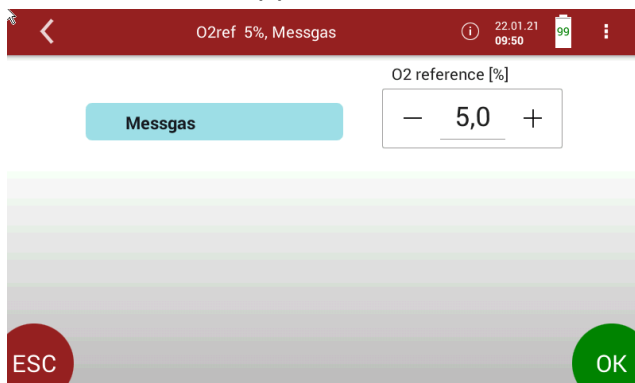

- ▶ Set the desired O₂ reference [%].
- ▶ Press OK.
 - ⇒ The set O₂ reference [%] is adopted.

Storing measured values

You can assign the measured values to the corresponding site and save them.

- ▶ Touch the menu Measure.
 - ⇒ The measurement window appears
- ▶ Touch the "Context menu" (19).
 - ⇒ A selection list appears.
- ▶ Touch „Store“.
- ⇒ A selection list appears.
- ▶ Choose the desired site.
 - ⇒ The measured values are stored.

The measurement continues until you switch off the analyser.

👉 See also Chapter Recalling stored measurements, Page 70.

Selecting channels for graphic display

You can log a maximum of eight channels simultaneously.

► Touch the menu

⇒ The measurement window appears.

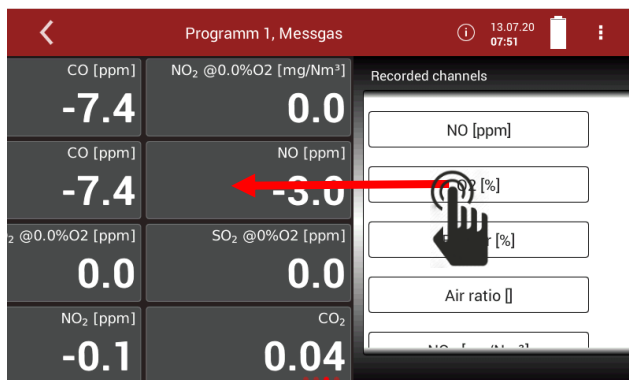

► Touch the display.

► Move the window to the left.

⇒ The window with "Recorded channels" appears.

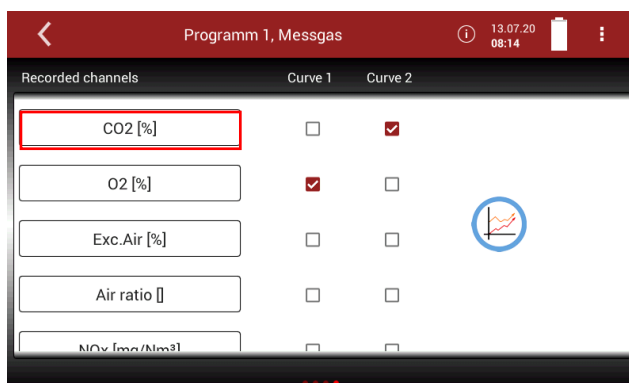

► Press a measurand that you want to replace.

⇒ A window appears.

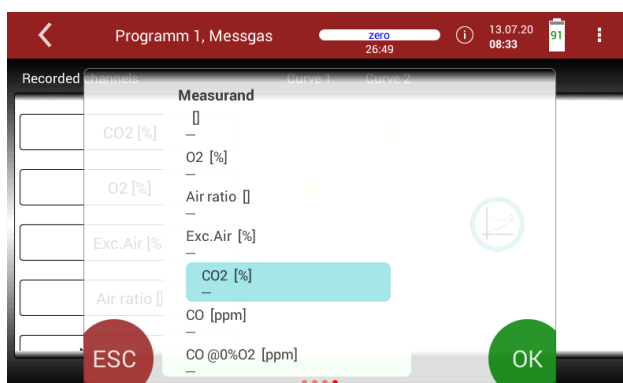

► Select the desired measurand.

► Press OK.

⇒ The measurand is replaced.

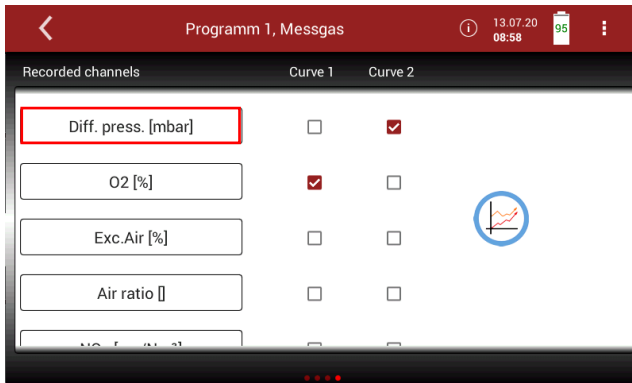

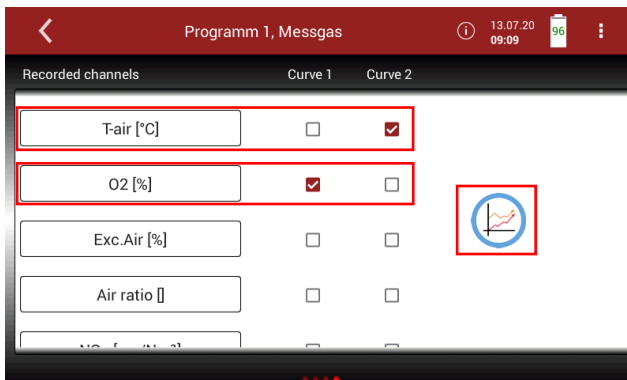

You have the possibility to display two measurands simultaneously as a curve.

- ▶ Set check marks at "Curve 1" and "Curve 2" for the measurands you want to display as a curve.

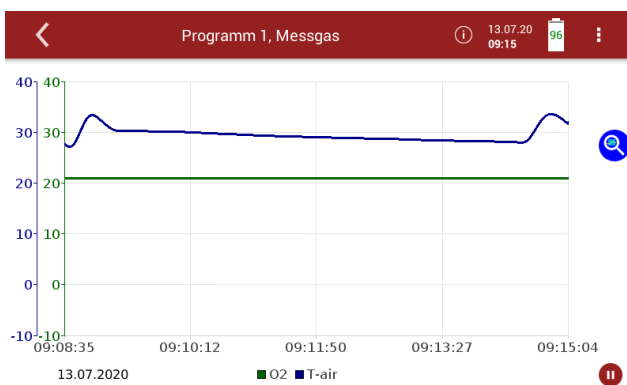

- ▶ Press the graphic symbol.
⇒ A diagram appears.



- ▶ If necessary, touch  to stop the graphical display. The measurement will be continued in the background.
- ▶ If necessary, touch  to continue the graphical display.

Starting Auto-measurement

You can record the measured values for a defined period and have them displayed graphically.

► Touch the menu Measure.

⇒ The measurement window appears.

Programm 1, Messgas		
Status []	CO [ppm]	NO ₂ @0.0%O ₂ [mg/Nm ³]
● zero ● flow ● air ● purge	-32.9	0.0
CO ₂	CO [ppm]	NO [ppm]
0.05	-32.9	-5.5
SO ₂ [ppm]	SO ₂ @0.0%O ₂ [ppm]	SO ₂ @0%O ₂ [ppm]
-0.2	0.0	0.0
Diff. press. [mbar]	NO ₂ [ppm]	CO ₂
0.01	-0.1	0.05

► Touch the "Context menu" (19).

⇒ A selection list appears.

► Touch „Start logging “

⇒ A setting window appears.

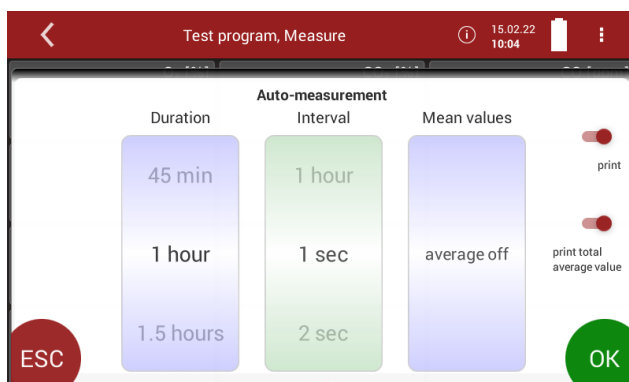

► Set the desired measurement duration.

► Set the desired interval.

► Specify whether a mean value is to be calculated.

► Touch „OK “

⇒ The window „Please select site“ appears.

► Select the desired site.

⇒ The Auto-measurement starts automatically.

⇒ The Auto-measurement ends automatically.

⇒ A protocol of the Auto-measurement appears

Average measurement		
Average values:		13.07.2020 09:41:47
Status	112	
CO	-32.9	ppm
NO2 @0.0%O2	0.0	mg/Nm ³
CO2	0.05	%
NO	-4.9	ppm
SO2	-0.1	ppm
SO2 @0.0%O2	0.0	ppm
SO2 @0%O2	0.0	ppm
Diff. press.	0.01	mbar
NO2	-0.1	ppm
CO @0.0%O2	0.0	mg/Nm ³
T-air	27.6	°C

▶ Press the graphic symbol.

⇒ A diagram appears.

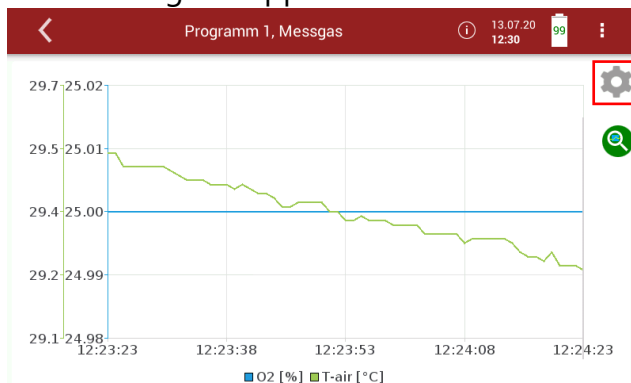

▶ If necessary, press the gear wheel symbol to display other measurands in graphical form.

You can also export or print the data of the automatic measurement.

▶ Insert a USB-stick into the analyser.

▶ Touch the context menu.

⇒ A Selection list appears.

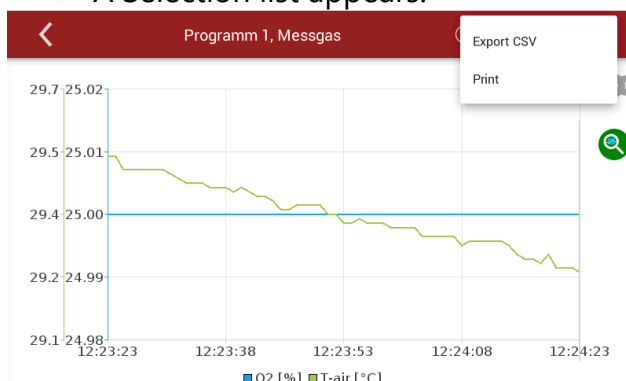

▶ Select Export CSV or Print.

⇒ The data is exported or printed

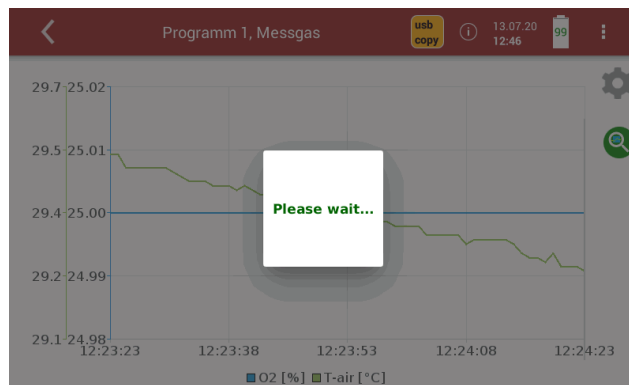
**NOTE**

If a zero point was taken during a running continuous recording (manually initiated or by a set time interval), the measured values are kept constant in the display. Immediately before the end of the zeroing, the real measured values are displayed again.

7 Data storage⁶

7.1. Organizing data storage

Base of the data memory of the analyser is a set of sites stored in the instrument. Every site exists of a unique site number and 12 freely usable text lines which can have, e.g., the address, customer name etc.

- The instrument can store up to 1.000 different sites.
- Sites can be created in the instrument and be changed.
- Measurements are stored by assigning them to a site.
- Measurements can be, on this occasion, singles flue gas measurements or other measuring programs available in the instrument.

7.2. Managing sites

In the menu Site, you can add a new site, make changes on an added site, delete a site and display a list of saved sites.

Adding a new site

► Press the menu Sites.

⇒ A window appears.

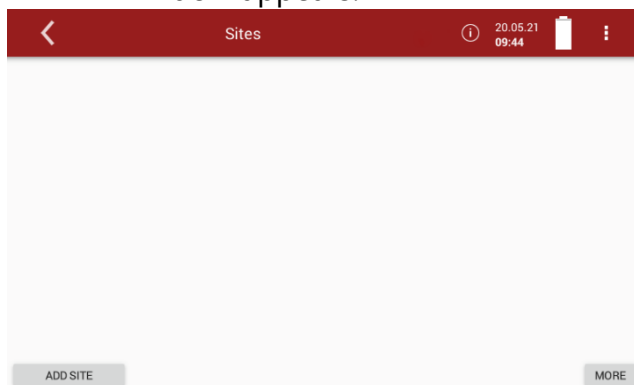

► Press „ADD SITE“.

⇒ A window appears.

⁶ The data storage is not part of the proof according to DIN EN 15267-4. See also chapter 2.1 Intended use, Page 8.

- ▶ Enter the site data.
- ▶ Press „SAVE“.
- ⇒ The site is saved.

Changing site data

- ▶ Press the menu Sites.
- ⇒ A selection list appears.

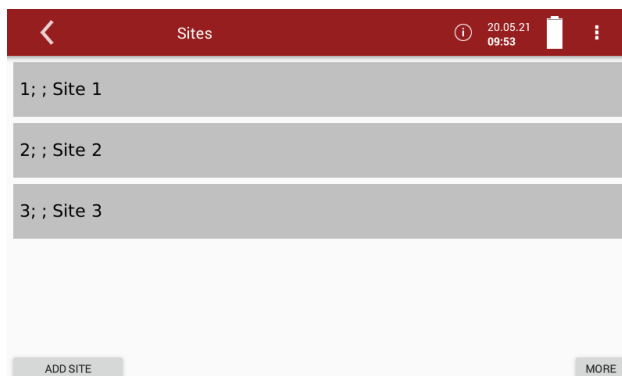

- ▶ Select the desired site.
- ⇒ A window appears.

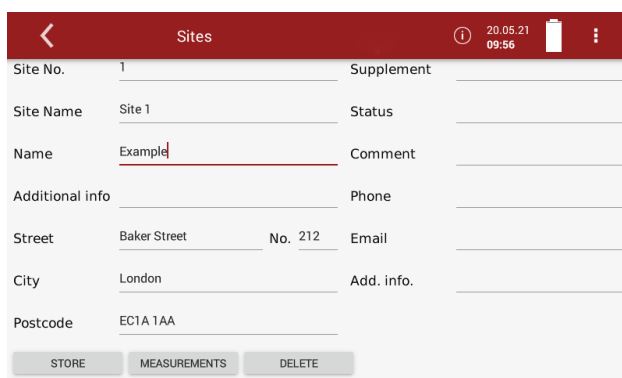

- ▶ Change the desired data.
- ▶ Press STORE.
- ⇒ The changes are stored.

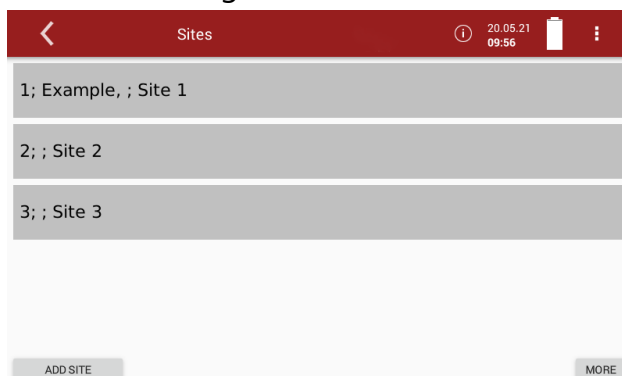

Deleting sites

► Touch the menu Sites.

⇒ A selection list appears.

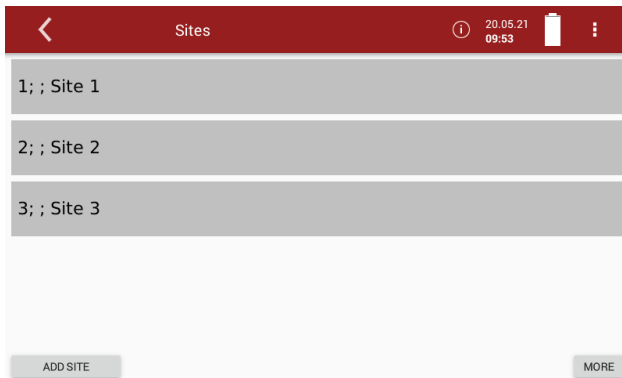

► Select the desired site.

⇒ A window appears.

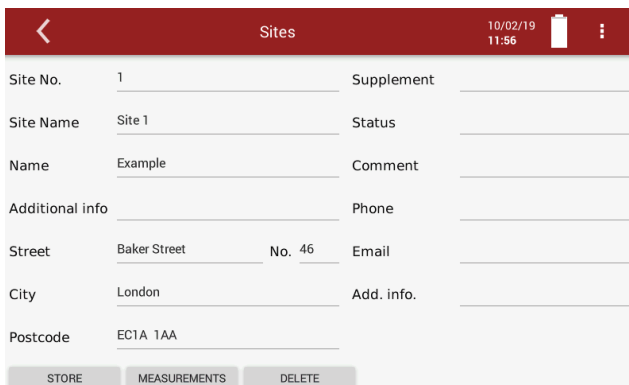

► Press Delete.

⇒ The site is deleted.

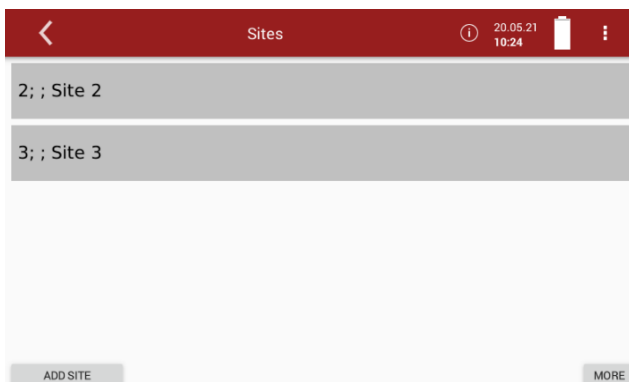

Recalling stored measurements

Stored measurement can be displayed individually for each site.

- ▶ Press the menu Sites.
 - ⇒ A selection list appears.
- ▶ Press the desired site.
 - ⇒ A window appears.

- ▶ Press MEASUREMENTS.
 - ⇒ A selection list appears.

- ▶ Press the desired measurement.
 - ⇒ The measurement window appears.

Delete stored measurements

There are two ways to delete measurements.

- You can delete measurements individually.
- You can select several measurements and delete them at the simultaneously.

- ▶ Press the menu sites.
 - ⇒ A selection list appears.
- ▶ Press the desired site.
 - ⇒ A window appears.

Site No. 1 Supplement

Site Name Site 1 Status

Name Example Comment

Additional info Phone

Street Baker Street No. 46 Email

City London Add. info.

Postcode EC1A 1AA

STORE MEASUREMENTS DELETE

► Press MEASUREMENTS.

⇒ The stored measurements are displayed.

19.01.2022 13:18:13, ,

19.01.2022 13:42:33, ,

20.01.2022 09:55:07, ,

20.01.2022 10:32:57, ,

20.01.2022 11:07:51, ,

EXPORT CHECKED AS CSV EXPORT CHECKED IN ONE FILE DELETE CHECKED SELECT ALL

Delete single measurement

► Press 

⇒ A message appears.

19.01.2022 13:18:13, ,

19.01.2022 13:42:33, ,

20.01.2022 09:55:07, ,

20.01.2022 10:32:57, ,

20.01.2022 11:07:51, ,

DELETE measurement?
Are you sure?
YES NO

EXPORT CHECKED AS CSV EXPORT CHECKED IN ONE FILE DELETE CHECKED SELECT ALL

► Press YES

⇒ The selected measurement is deleted.

Delete several measurements

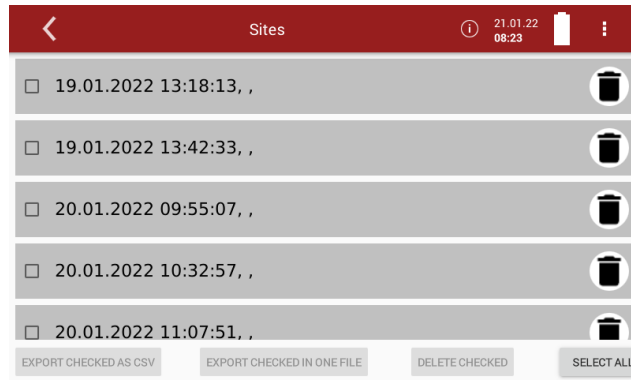

► Select the measurements you want to delete.

⇒ The button DELETE CHECKED becomes active.

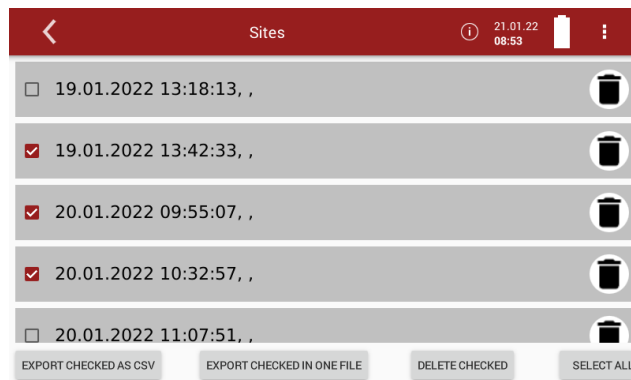

► Press the button DELETE CHECKED.

⇒ A message appears.

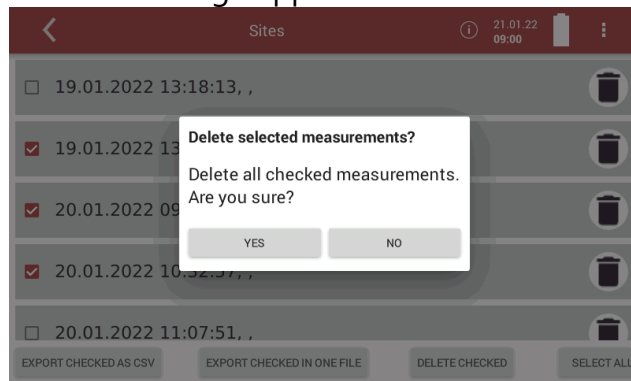

► Press YES.

⇒ The selected measurements are deleted.

7.3. Data transfer via USB (CSV export)

The data exchange format is CSV. A character-separated values (CSV) file is a simple text format for a database table. The analyser uses a semicolon ';' as value separator. CSV is a simple file format that is widely supported, so it is often used to move tabular data between different computer programs, for example Microsoft Excel™ or Access™, that support the format.

The following functions are available

- Export of flue gas measurements
- ▶ Insert a USB-stick into the analyser.
- ▶ Press the menu Sites.
- ⇒ A selection list appears.



- ▶ Select the desired site.
- ⇒ A window appears.

The screenshot shows a mobile application interface with a dark red header bar. The header contains a back arrow, the title 'Sites', a status icon, the date and time '26.01.21 10:21', and battery and signal icons. Below the header is a form for editing site information. The form has two columns of fields: 'Site No.' (7), 'Supplement' (empty), 'Site Name' (Site 7), 'Status' (empty), 'Name' (Example), 'Comment' (empty), 'Additional info' (empty), 'Phone' (empty), 'Street' (Backer Street No. 46), 'Email' (empty), 'City' (London), 'Add. info.' (empty), and 'Postcode' (EC1A 1Aa). At the bottom of the form are three buttons: 'STORE', 'MEASUREMENTS', and 'DELETE'.

- ▶ Press MEASUREMENTS
- ⇒ The stored measurements are displayed.



You have the option to export measurements as single files.
 You have the option of exporting several measurements in one file.

► Select the desired measurements.

- ⇒ The button EXPORT CHECKED AS CSV becomes active
- ⇒ The button EXPORT CHECKED IN ONE FILE becomes active.

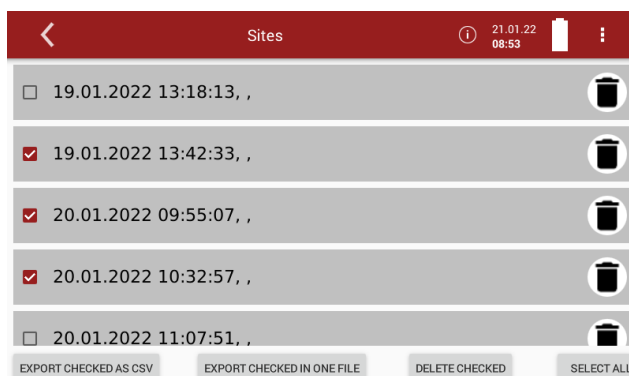

► Press EXPORT CHECKED AS CSV or EXPORT CHECKED IN ONE FILE.

- ⇒ Depending on the selection, the measurements are exported individually or all selected measurements are exported in one file.
- ⇒ A message appears.

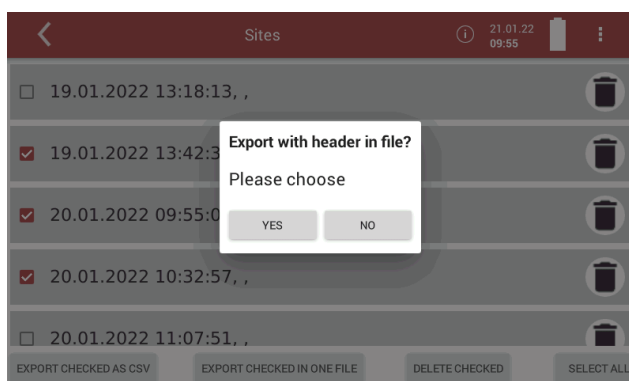

► Select, if you want to export with header in file.

- ⇒ The directory 1113Export is created on the USB stick.
- ⇒ The selected measurements are stored in the 1113Expordirectory.

► Open the CSV file.

(Do not use dat-files or internal log files)

Export with header

1	Device data: MGAprime 063450				
2	Site data: Site 1 Example				
3	Date	Time		O2ref %	O2 %
4	20.05.2021	10:31:01	---	10	20,92

Export without header

1	Date	Time		O2ref %	O2 %
2	20.05.2021	10:31:01	---	10	20,92
3	20.05.2021	10:31:48	---	10	20,91
4	20.05.2021	10:32:21	---	10	20,93
5	20.05.2021	10:40:29	---	10	20,93

8 Extras

8.1. Open menu Extras

- ▶ Press Extras

⇒ A list appears.

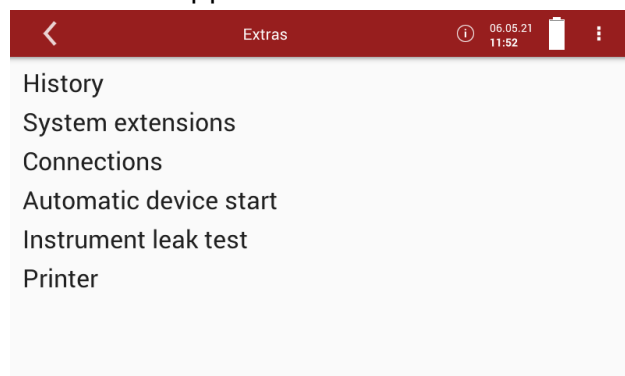

- ▶ Select the desired menu item.

8.2. History

- ▶ Open the menu Extras.

☞ See also chapter 8.1 Open menu Extras, Page 76.

⇒ A selection list appears.

- ▶ Press „History“.

⇒ A window appears.

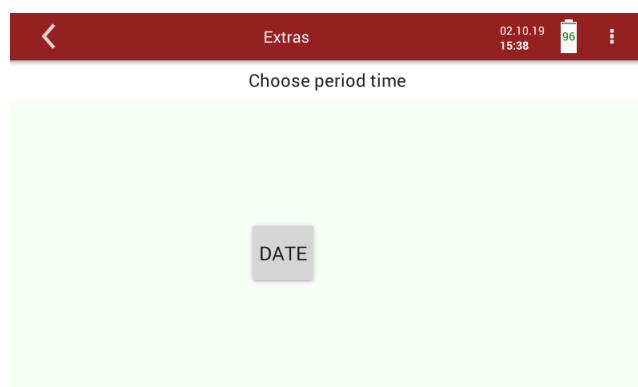

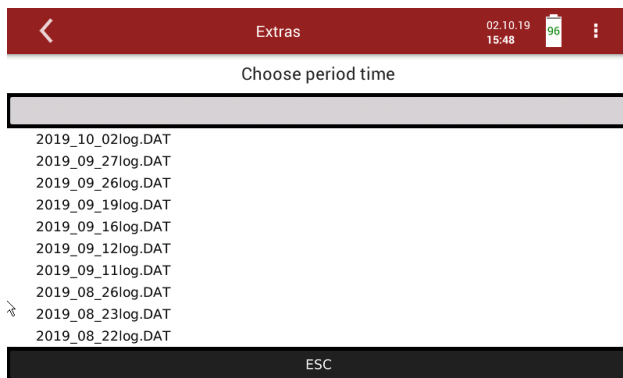

- ▶ Press „DATE“.

⇒ A selection list appears.

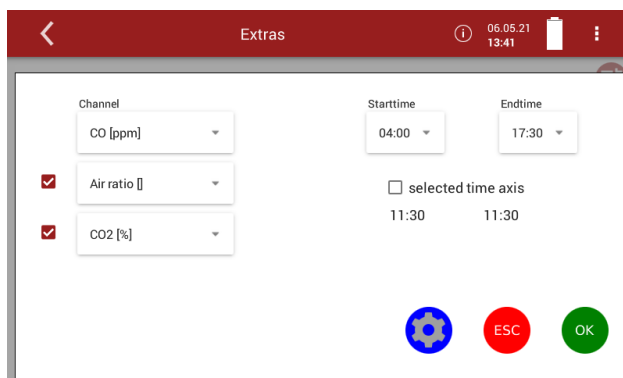
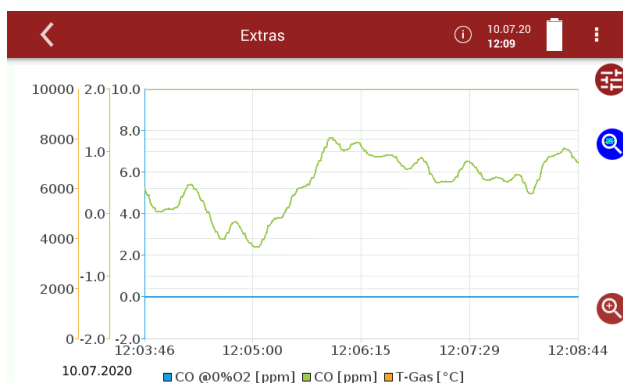

- ▶ Choose the desired period time.
 - ⇒ The chosen time period is displayed graphically.



- ▶ If necessary, press 
 - ⇒ A window appears.
 - ⇒ You have the possibility to change the displayed channels and to have them displayed graphically.
 - ⇒ You have the possibility to change the Starttime and the Endtime. You can activate or deactivate the selected time axis.

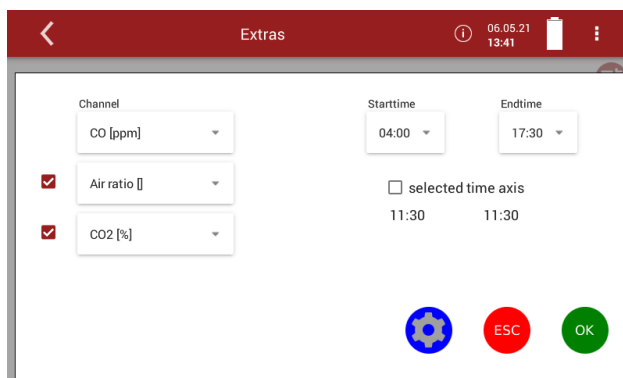

- ▶ If necessary, press 
- ⇒ A window appears.

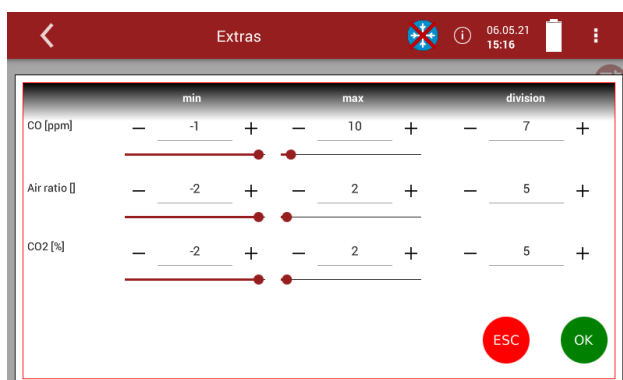

- ▶ You can set min. and max. and the division of the selected channels.
- ▶ Press Ok, to exit the window.

8.3. System extensions

You have the possibility to expand the analyser with options. For this you will receive an option file from the manufacturer.

- ▶ Copy the options file onto a USB stick.

NOTE



You can also save the option files in subfolders. The analyser will search the folder structure on the USB stick up to the second hierarchy level. Save the option file in the folder structure above, if the option file is not displayed

- ▶ Insert the prepared USB stick into the analyser
- ▶ Open the menu Extras.
 - ☞ See also chapter 8.1 Open menu Extras, Page 76.
- ▶ Press System extensions
 - ☞ A window appears.
 - ☞ The options stored on the USB stick are displayed.
- ▶ Press UPDATE LIST, if no options are displayed.

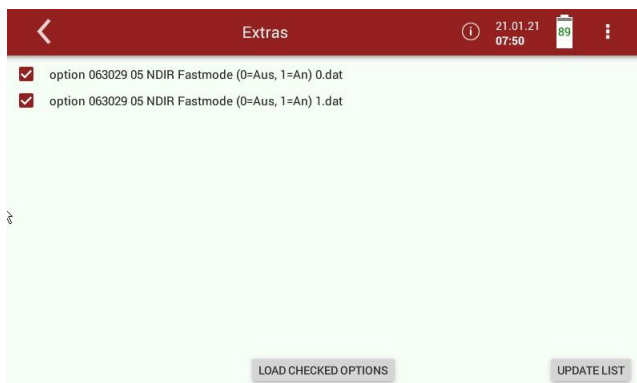

- ▶ Select the desired Options.
- ▶ Press LOAD CHECKED OPTIONS.
 - ☞ A message appears.

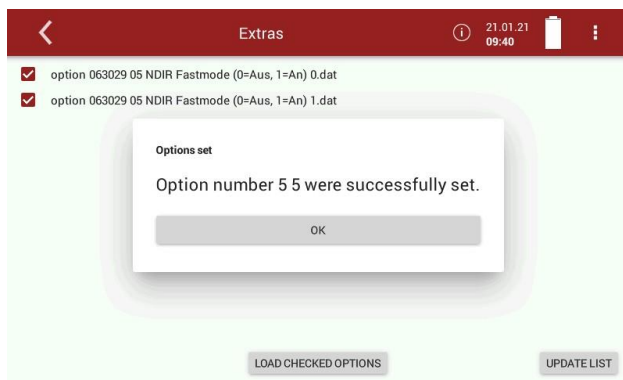

- ▶ Press OK.
 - ☞ The option was successfully set.
- ▶ Perform a restart.
 - ☞ After the restart, the option is available.

8.4. Connections

You can view the connections on the display of the analyser.

- ▶ Open the menu Extras.

☞ See also chapter 8.1 Open menu Extras, Page 76.

- ▶ Press Connections.

⇒ The Connections of the analyser are displayed.

☞ See also chapter 3.4 Connectors, Page 14.

8.5. Automatic device start

You have the possibility that the analyser performs an automatic device start at a time determined by yourself.

- ▶ Open the menu Extras.

☞ See also chapter 8.1 Open menu Extras, Page 76.

- ▶ Press Automatic device start

⇒ A window appears.

Extras 07.05.21 11:16 98

Please set time for next automatic start of device (max. 24h):

Time	Date
10 : 14	06 . 04 . 20
11 : 15	07 . 05 . 21
12 : 16	08 . 06 . 22

ACCEPT

- ▶ Set the desired time for the automatic device start.



NOTE

Note that you can set an automatic device start for max. 24 hours into the future.

A message is displayed if the time interval is too long.

- ▶ Press ACCEPT.

⇒ A message appears.

- ▶ Accept the message.

- ⇒ The time of the next automatic device start is taken over and shown in the display.

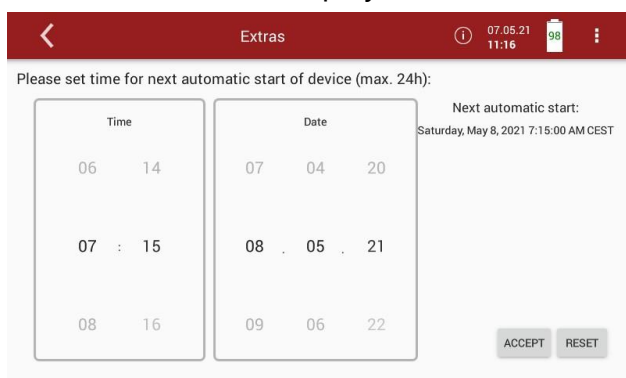

If you have activated an automatic device start, a message appears when the analyser is switched off.

- ▶ Pull the heating hose out of the analyser.
- ▶ Pull the probe out of the analyser.
- ▶ Press Yes.
 - ⇒ The system will shut down.

After the analyser has shut down, an LED lights up to indicate that an automatic device start has been set

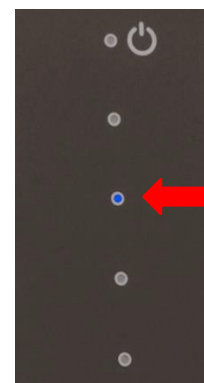

8.6. Instrument leak test

The analyser device has an integrated leak test to check the tightness of the gas paths.

- ▶ Check all plug connections for correct fit.
- ▶ Check all hoses and hose connections (from the probe tip to the gas inlet of the analyser) for leaks.
- ▶ Open the menu Extras.
 - ☞ See also chapter 8.1 Open menu Extras, Page 76.
- ▶ Press Instrument leak test.
 - ⇒ A window appears.
 - ⇒ If the analyser is still in the warm-up phase, no leak test can be performed. A corresponding message is displayed.

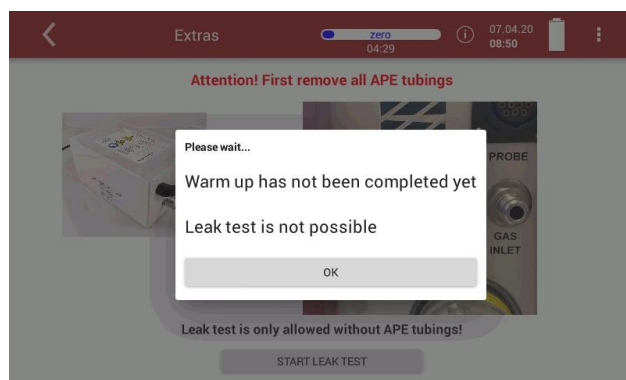

- ▶ Press OK.
- ▶ Wait until the warm-up phase is completed.

NOTE



Please note that no leak test can be performed with a connected Acid Dosing Unit APE. The Acid Dosing Unit APE is connected to the analyser via a connecting hose with two couplings

- ▶ Remove the two couplings from the analyser.
 - ⇒ Leak test is now available.

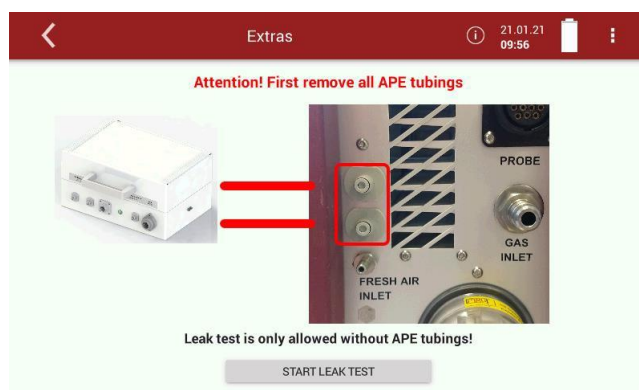

- ▶ Press START LEAK TEST
 - ⇒ A message appears.
- ▶ Confirm with YES, that the APE tubes are removed.
- ▶ Seal the gas port.

⇒ The leak test is performed

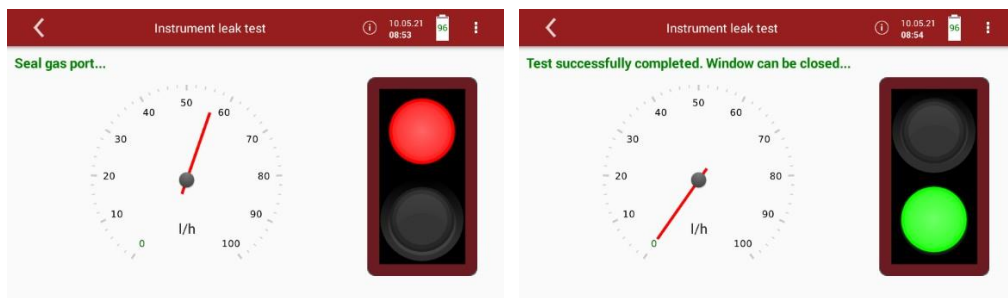

Or if the complete gas path is to be checked for leaks:



NOTE

With dirt and soot particles on the probe tube the test cap will not seal properly.

- ▶ The probe tip must be cleaned before you start this test.

- ▶ Seal off the tip of the probe a leak proof test cap.
 - ⇒ If the system is tight, the traffic light is green and the l/h pointer is 0.
- ▶ Exit the window.
 - ⇒ A message appears.

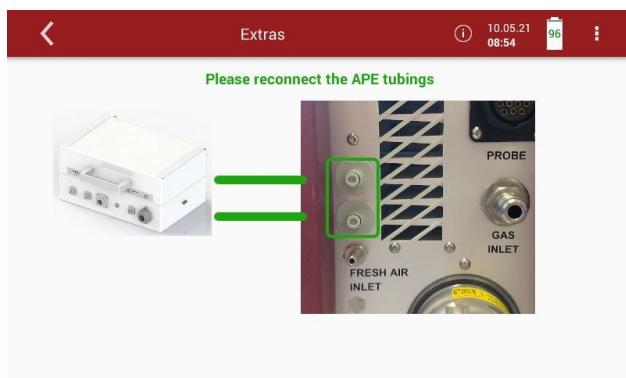

- ▶ Connect the Acid Dosing Unit APE to the analyser after you have performed the leak test.

NOTE

Note that measured values are invalid for four minutes after the Instrument leak test.

If you open the menu Measure, a corresponding message will be displayed

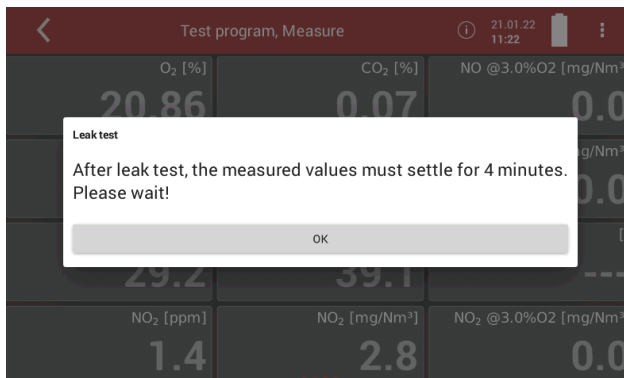

8.7. Printing measurement results

In the menu Printer, you can select the type of connection between an optional printer and the analyser.

You have 2 options to connect the printer:

- USB - connect with USB wire
- WiFi - internal WiFi

► Open the menu Extras.

☞ See also chapter 8.1 Open menu Extras, Page 76.

► Press Printer.

⇒ A window appears.

► Choose the desired option.

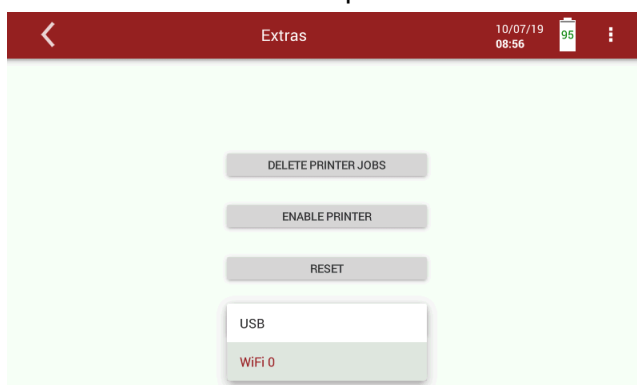

Printing current measurement results

- ▶ Switch on the printer.
- ▶ Go to the menu Measurement.
 - ⇒ The measurement window appears.
- ▶ Press the "Context menu" (19).
 - ⇒ A selection list appears.

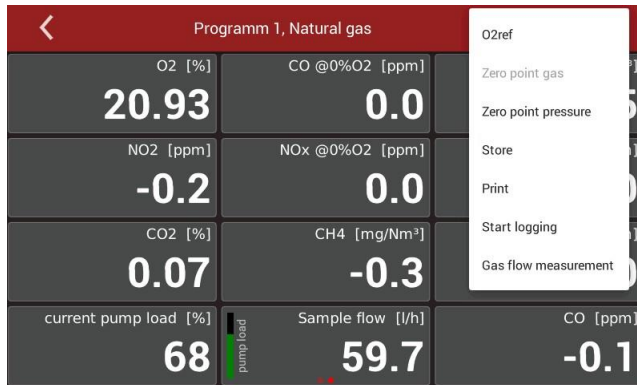

- ▶ Press Print.
 - ⇒ The measurement is printed out with a slight delay.

Printing stored measurement results

- ▶ Switch on the printer.
- ▶ Press the menu „Sites“.
- ⇒ A selection list appears

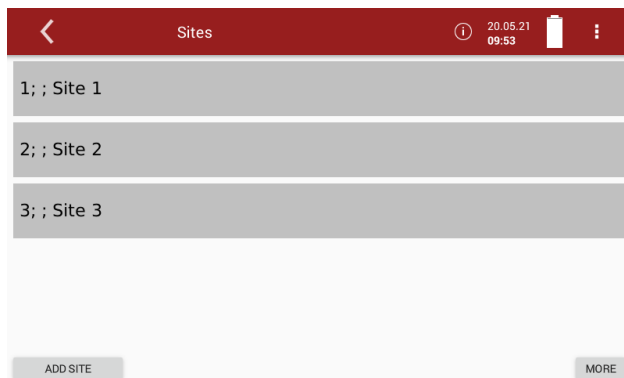

- ▶ Press the desired site.
 - ⇒ A window appears.

► Press MEASUREMENTS.

⇒ The stored measurements are displayed.

02.10.2019 13:08:05, Measurement,
02.10.2019 13:08:33, Measurement,
02.10.2019 13:08:52, Measurement,
02.10.2019 13:10:35, Measurement,

► Press the desired measurement.

⇒ The measurement window appears.

► Press the context menu (19).

	O2 [%] 20.93	
Exc. Air [%] ---	CO2 [%] -0.02	CO [ppm] 0.3
CO @0%O2 [ppm] 0.0	CO @3.0%O2 [ppm] 0.0	CO @3.0%O2 [mg/Nm ³] 0.0
CO @3.0%O2 [g/Nm ³] 0.000	CO [mg/Nm ³] 0.4	CO [g/s] 0.000

⇒ A selection list appears.

► Press „Print“.

⇒ The measurement is printed out with a slight delay

9 Service

9.1. Open menu Service

▶ Press Service

⇒ A list appears.

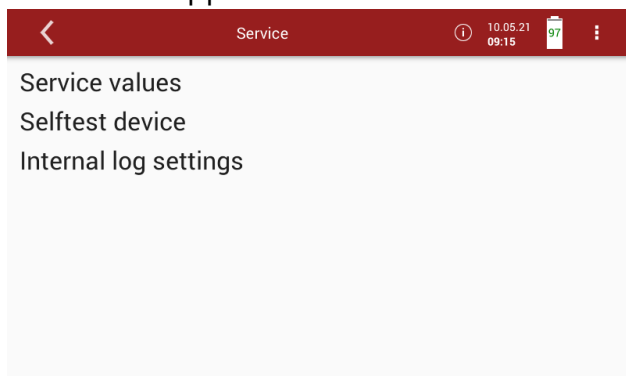

▶ Select the desired menu item.

9.2. Service values

This screen displays a number of internal parameters and their values. In case of unexpected behaviour of the analyser it might be helpful to communicate those values to our worldwide service staff:

<https://www.mru.eu>

▶ Open the menu Service.

☞ See also Chapter 9.1 Open menu Service, Page 87.

▶ Press Service values.

⇒ Internal parameters and their values appear.

Modbus-Device:	86	<<<<<<	receive
TX counter:		60	
Errors:		0	
AbsPressure	100	6.883	mV
AbsPressure	102	1003.4	hPa
Temperatur	104	552.25	mV
Temperatur	106	55.2	°C

9.3. Performing Device selftest

With the Device selftest you can test certain parameters of the analyser.

- ▶ Open the menu Service.

- ☞ See also Chapter 9.1 Open menu Service, Page 87.

- ▶ Press Selftest device.

- ☞ A window appears.

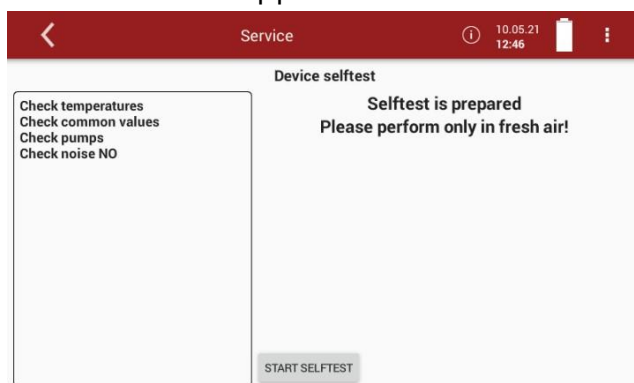

- ▶ Press START SELFTEST.

- ☞ The Device Selftest starts.

- ☞ As long as the Device selftest is running,  appears in the display.

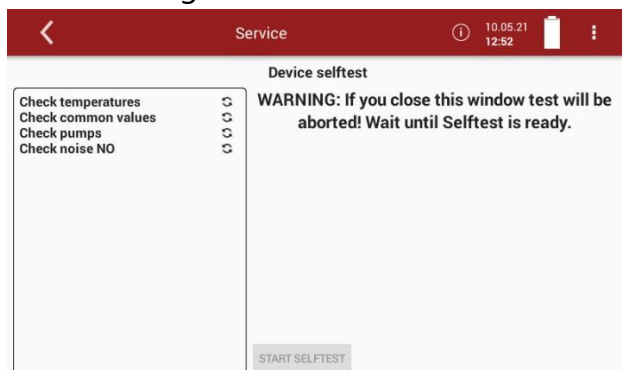

- ☞ The Device selftest stops automatically.

- ☞ A successful Device selftest is indicated with  in the display for each individual parameter.

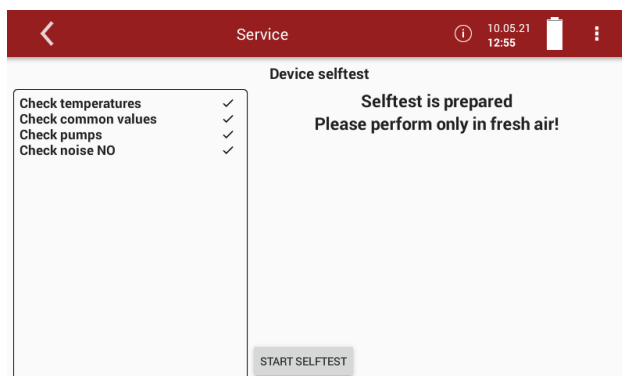

If the Device selftest for a particular parameter was not successful **X** is shown in the display.

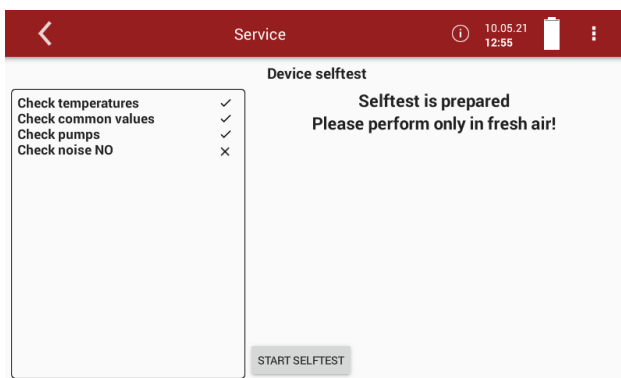

In the case of an Error message, please contact our customer service or contact one of the worldwide MRU service partners via www.mru.eu

9.4. Internal log settings

The analyser stores internal parameters at regular intervals to allow for an optimized support from experienced service staff. These files can be copied to a connected USB stick and sent via email if required to do so. The data will be anonymized. It is not possible to identify sites or measuring points.

Copying all log data

- ▶ Insert a USB-stick into the analyser.
- ▶ Open the menu Service.
 - ☞ See also Chapter 9.1 Open menu Service, Page 87.
- ▶ Press Internal log settings.
 - ⇒ A window appears.

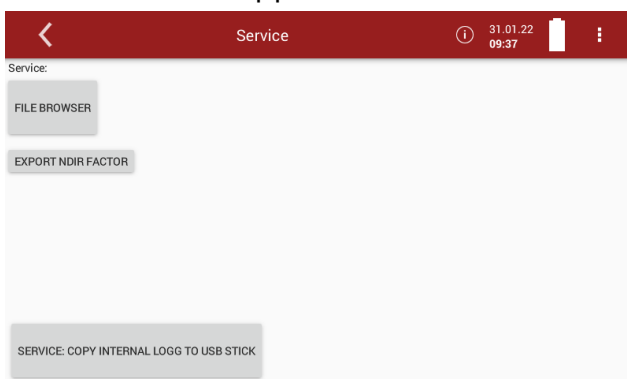

- ▶ Press „SERVICE: COPY INTERNAL LOGG TO USB STICK“.
- ⇒ A window appears.
- ⇒ The copy process is started.
- ⇒ A Symbol appears in the Display

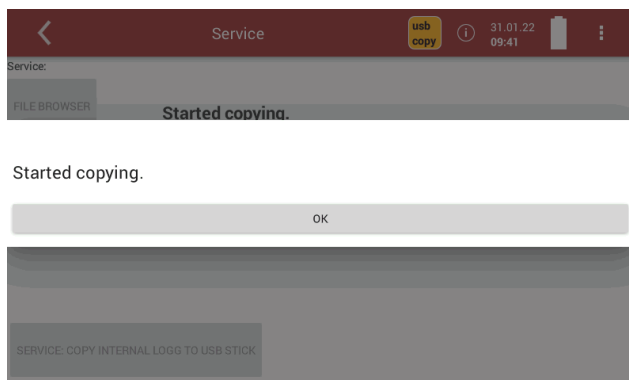

- ▶ Press OK.
- ⇒ The directory [serial number] Logg was created on the USB-Stick.
- ⇒ The log files are saved in the directory [serial number].
- ⇒ After copying, the display shows "File(s) successfully copied".
- ▶ Press OK.

**NOTE**

If the analyser is operated for a long time, the copying process can take a long time.

Copying single log data

- ▶ Insert a USB-stick into the analyser.
- ▶ Open the menu Service.
 - ☞ See also Chapter 9.1 Open menu Service, Page 87.
- ▶ Press Internal log settings.
 - ⇒ A window appears.

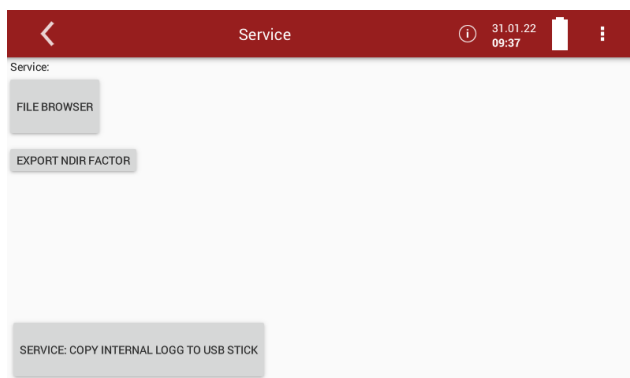

- ▶ Press FILE BROWSER
 - ⇒ A selection list appears.

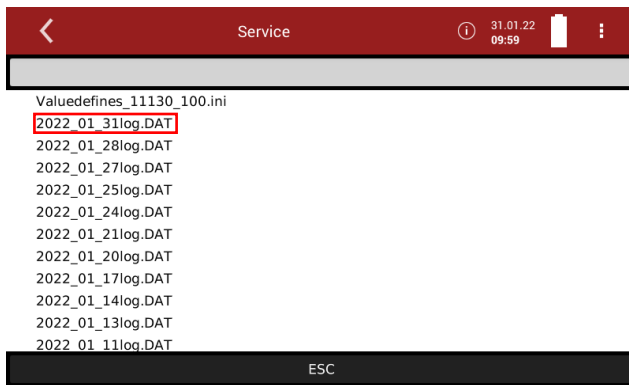

- ▶ Press the desired log file.
 - ⇒ A window appears.
 - ⇒ The desired log file appears in the window.

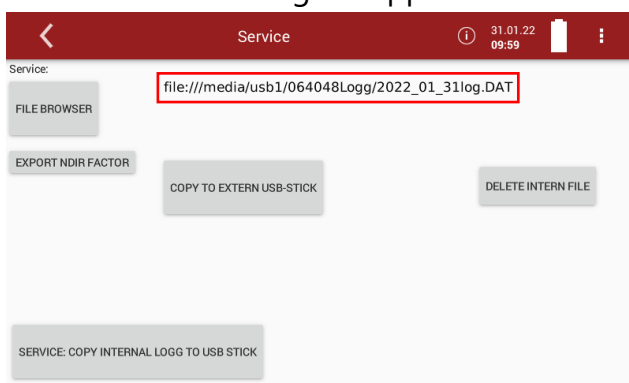

- ▶ Press COPY TO EXTERN USB-STICK.
 - ⇒ A window appears.
 - ⇒ The copy process is started.

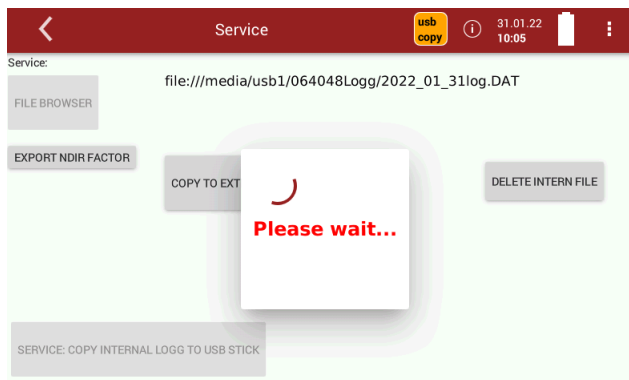

- ⇒ The directory [serial number] Logg was created on the USB-Stick.
- ⇒ The log files are saved in the directory [serial number].
- ⇒ After copying, the display shows "File(s) successfully copied".
- ▶ Press „OK

Export NDIR- Factors

If your analyser has an NDIR cuvette, you can export the NDIR factors to a USB stick.

- ▶ Insert a USB-stick into the analyser.
- ▶ Open the menu Service.
 - ☞ See also Chapter 9.1 Open menu Service, Page 87.
- ▶ Press Internal log settings.
 - ☞ A window appears.

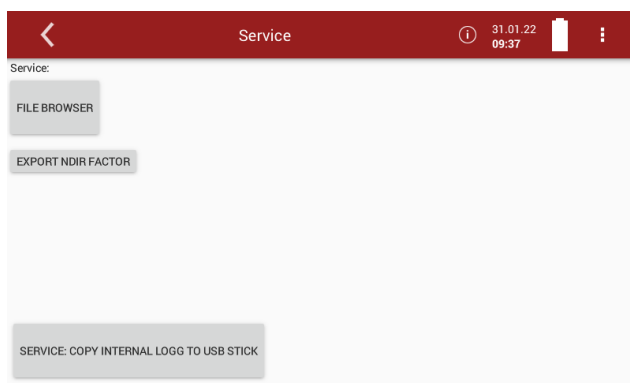

- ▶ Press EXPORT NDIR FACTOR.
 - ☞ The NDIR factors are exported.
 - ☞ On the USB stick, the folder NdirFactors is created.
 - ☞ The NDIR factors are stored in the folder NdirFactors.
 - ☞ A message appears.

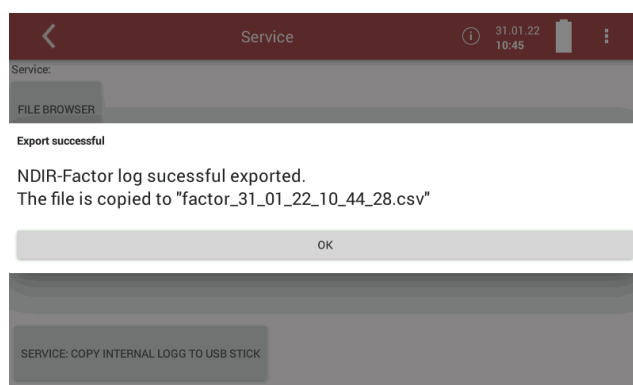

- ▶ Press OK.

10 Info

10.1. Open menu Info

► Press Info

⇒ A window appears.

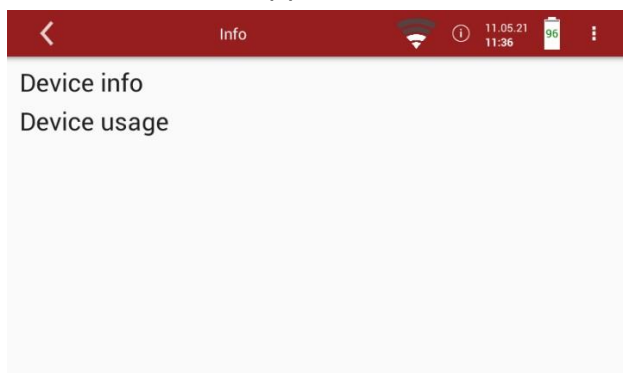

► Select the desired menu item.

10.2. Calling up device info

In the menu Device info, you can, for example, display the serial number, the firmware version and version information for installed modules and installed options.

► Open the menu Service.

☞ See also Chapter 9.1 Open menu Service, Page 87.

► Press Device info.

⇒ A window appears.

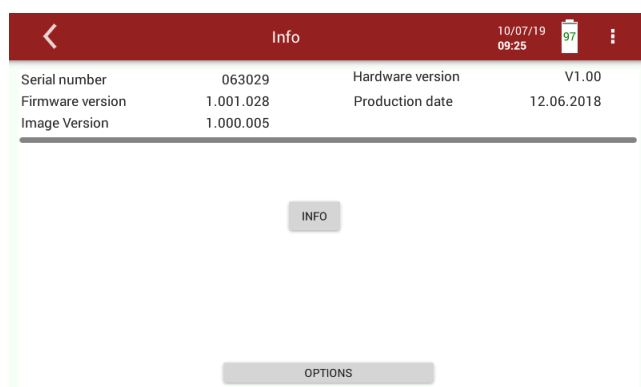

► Press INFO

⇒ A window appears.

⇒ Version information for specific modules is displayed

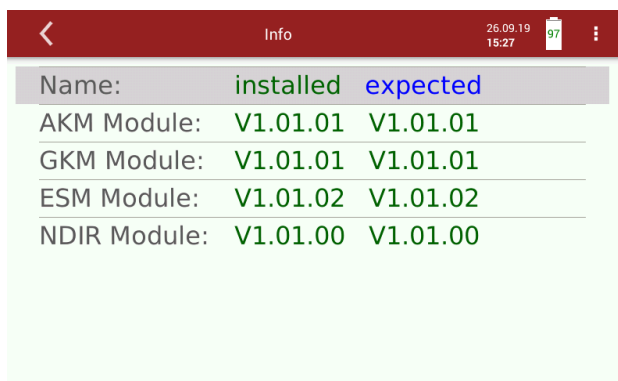

- ▶ Exit the window.
- ▶ Press OPTIONS.
- ⇒ A window appears.

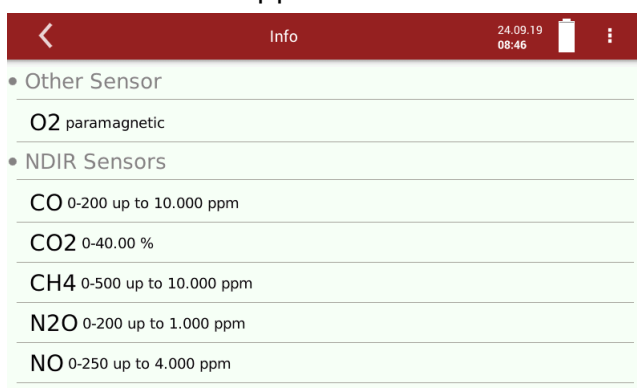

10.3. Device usage

You have the possibility of displaying the operating time of the analyser, the total usage of certain analyser components and the remaining usage time until the next maintenance.

- ▶ Open the menu Service.
 - ☞ See also Chapter 9.1 Open menu Service, Page 87.
- ▶ Press Device usage.
 - ⇒ A window appears.

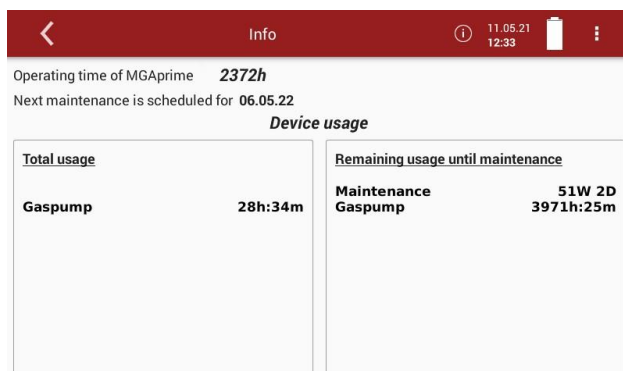

If a device component has exceeded the prescribed service life, the analyser should be maintained immediately at a service centre.

11 Entering Pin code

Entering a password enables authorized personnel to calibrate the sensors. The password is available from the producer on request.

Not required for regular operation of the analyser.

Manual calibration of O₂ is not possible.

▶ Press 

⇒ A window appears.

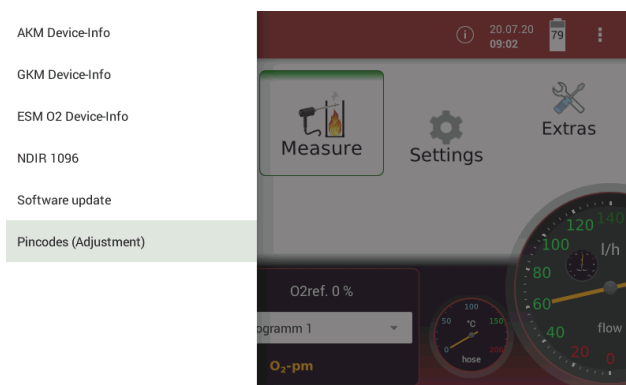

▶ Press Pincodes (Adjustment)

⇒ A window appears.

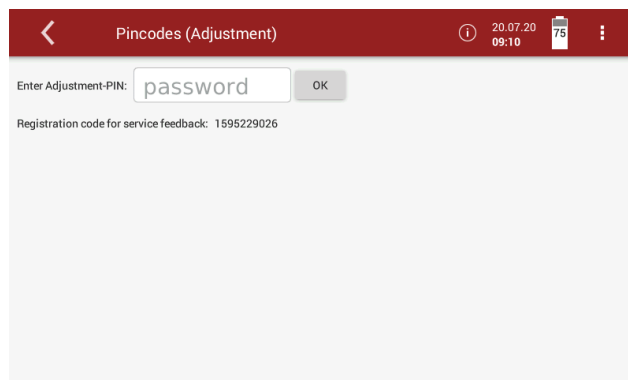

▶ Enter the Pin code

▶ Confirm the pin code.

12 Calibrating NDIR cuvette

The zero point of the NDIR measuring channels is taken at the end of the warm-up phase after switching on the analyser (or manually triggered after entering a PIN code).

The user has the possibility to carry out a reference point calibration by feeding test gas. This calibration is only possible for authorized users after entering the PIN code.

- ▶ You have the possibility of performing a 1-point adjustment or a 2-point adjustment.
- ▶ Ensure that the analyser has been warmed up for at least one hour.
- ▶ Ensure that the zero point has been taken in ambient air that is free of harmful gases.
- ▶ Pay particular attention to the fact that a high CO₂ content, as can occur in the vicinity of people, can lead to incorrect adjustment.

12.1. Connecting analyser to sample gas cylinder

It is recommended to connect the sample gas cylinder to the analyser via a bypass (see drawing below). The analyser draws an average sample gas flow of 60 l/h. The total volume flow from the gas bottle should be slightly higher than 60 l/h (approx. 5...10 l/h higher than 60 l/h)

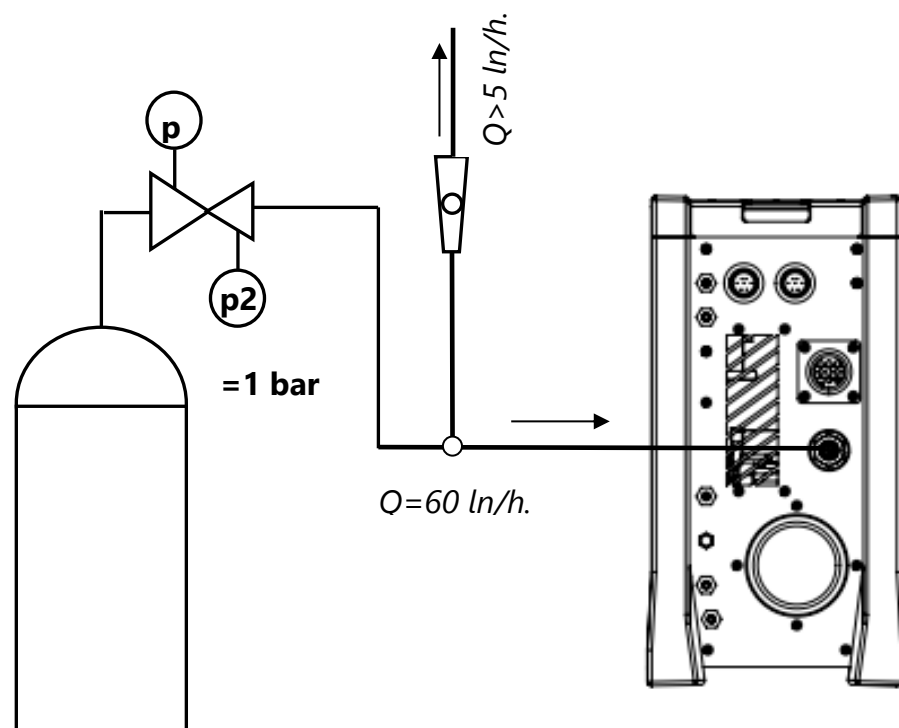

12.2. Open adjustment window

Before you can open the adjustment window, you need to enter a PIN code.

☞ See also chapter 11 Entering Pin code, Page 95.

The pin code is available on request from the manufacturer.

▶ Press 

⇒ A selection list appears.

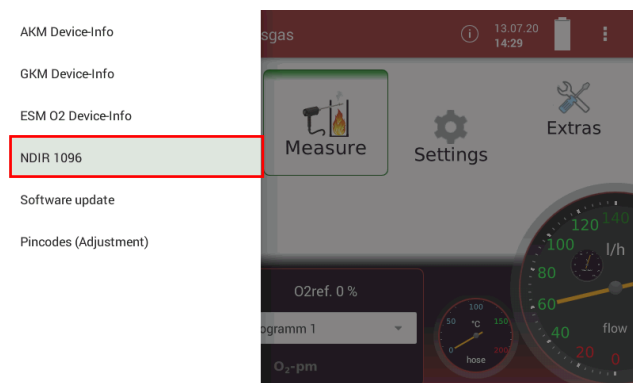

▶ Press NDIR 1096.

⇒ A window appears.

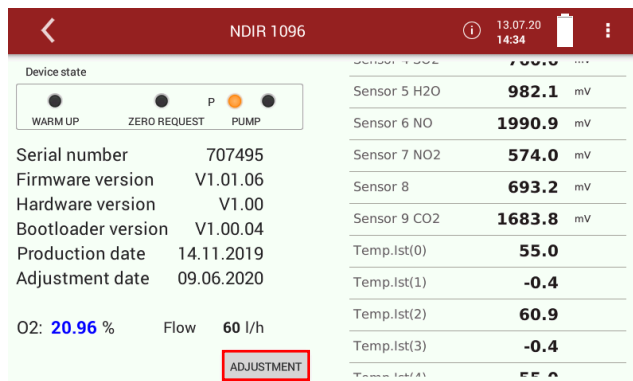

▶ Press ADJUSTMENT.

⇒ The adjustment window opens.

▶ Select if you want to perform a 1-point adjustment or a 2-point adjustment.

⇒ The adjustment window changes accordingly.

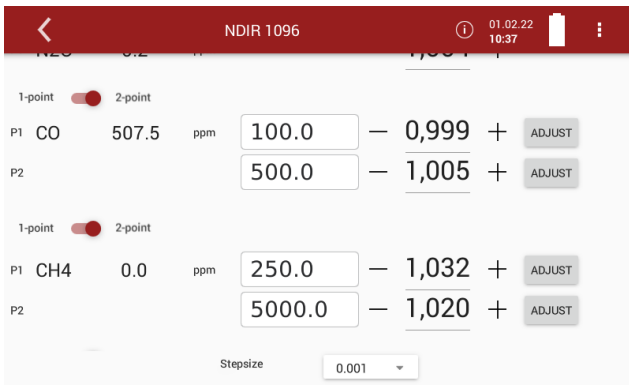

2-point adjustment

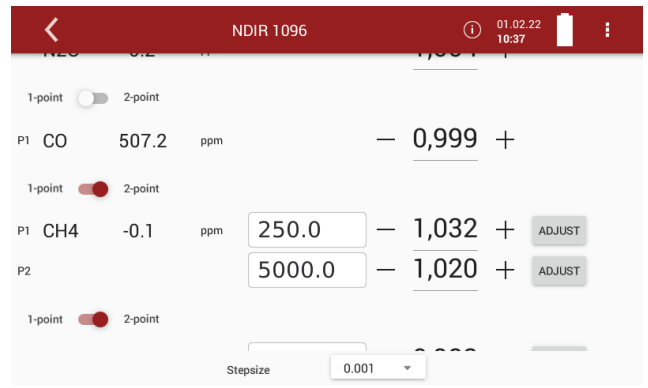

1-point adjustment

12.3. Perform a 2-point adjustment

- ▶ Connect the sample gas cylinder to the analyser.
 - ☞ See also Chapter 12.1 Connecting analyser to sample gas cylinder, Page 96.
- ▶ Open the adjustment window.
 - ☞ See also Chapter 12.2 Open adjustment window, Page 97.



NOTE

Do not carry out the adjustment until the analyser has been warmed up for at least one hour and zeroing has been completed.

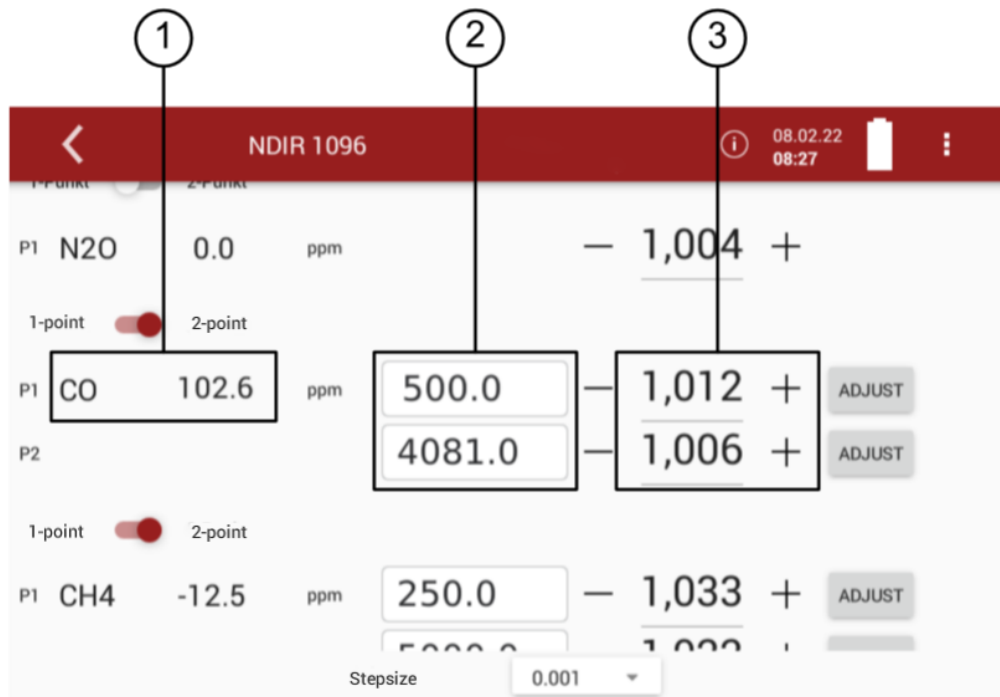

Position	Description
1	gas / current value
2	setpoint concentrations
3	currently set overfactors

► Enter the desired test gas concentration.



NOTE

Perform adjustment first for the lower adjustment point P1.



NOTE

Ideally this is done from a test gas bottle with pressure reducer and a T-piece through which excess gas can flow off. From this T-piece the analyser sucks in the required gas quantity without pressure.

► Write the sample gas value of the sample gas cylinder in the field for the set concentrations. To write the value in the field, touch the field and enter the value with the appearing keypad. The value must be confirmed with the hook.

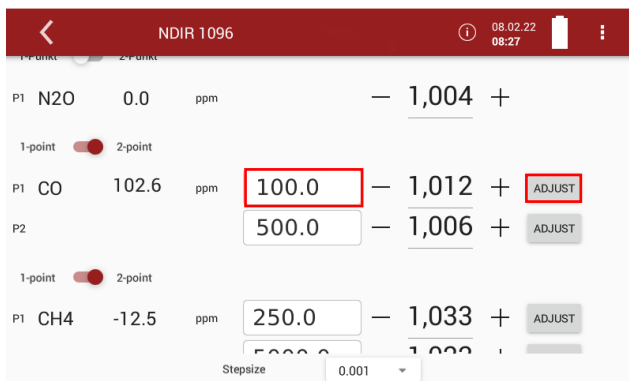

NOTE

The analyser checks the entered values for plausibility. If the entered values contradict certain criteria stored in the analyser, a corresponding message is displayed.

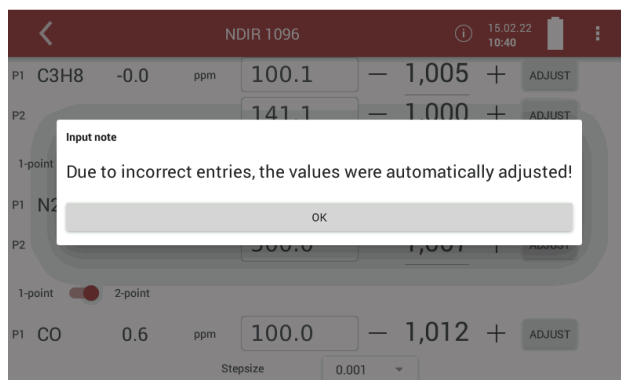

- ▶ Wait until a stable gas value is reached.
 - ⇒ This usually takes three to five minutes.
- ▶ Press ADJUST.
 - ⇒ The adjustment factor for the measuring channel changes.

NOTE

Smaller corrections to the adjustment factor can also be entered manually using the plus/minus keys.

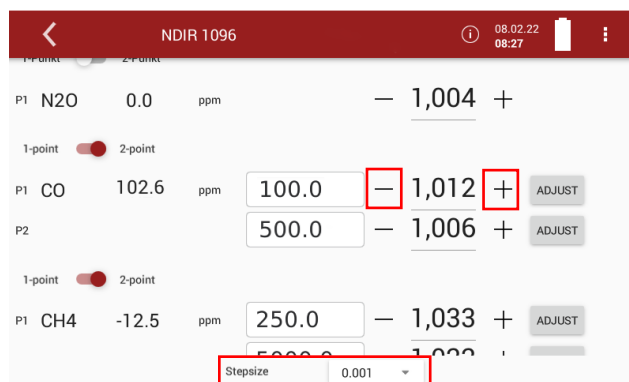

- ▶ If necessary, change the resolution under Stepsize.

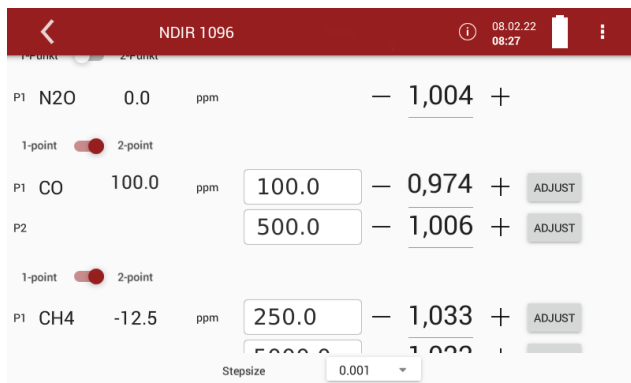

- ▶ Repeat the adjustment procedure for the upper adjustment point P2.
- ▶ Exit the adjustment window.
 - ⇒ A button appears in the display.

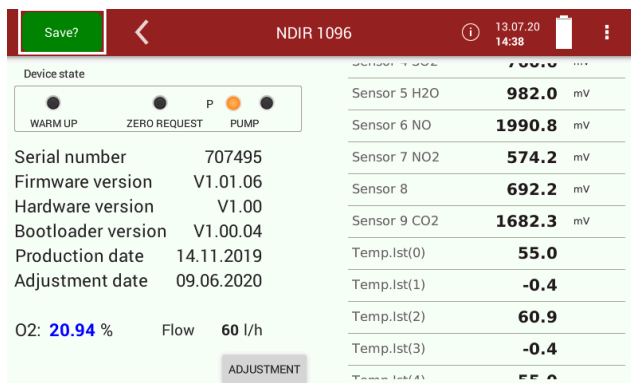

- ▶ Press Save?
 - ⇒ The adjustment factors are saved.

NOTE



You have the possibility to export the adjustment factors.

⇒ See also chapter Export NDIR- Factors, Page 92.

12.4. Perform a 1-point adjustment

The goal of the 1-point adjustment is to allow the user to simplify the adjustment, as in most cases the user only has one gas concentration available.

They can apply this gas concentration to the analyser and adjust the reading by a parameter.

- ▶ Connect the sample gas cylinder to the analyser.
 - ☞ See also Chapter 12.1 Connecting analyser to sample gas cylinder, Page 96.
- ▶ Open the adjustment window.
 - ☞ See also Chapter 12.2 Open adjustment window, Page 97.

NOTE

i

Do not carry out the adjustment until the analyser has been warmed up for at least one hour and zeroing has been completed.

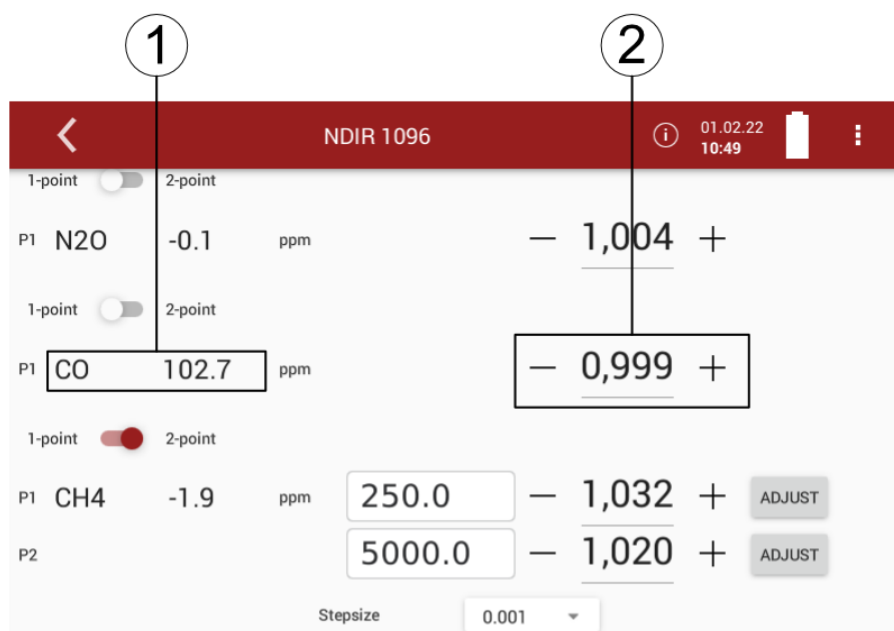

Position	Description
1	gas / current value
2	currently set overfactor

- ▶ Enter the desired test gas concentration.



NOTE

Ideally this is done from a test gas bottle with pressure reducer and a T-piece through which excess gas can flow off. From this T-piece the analyser sucks in the required gas quantity without pressure.

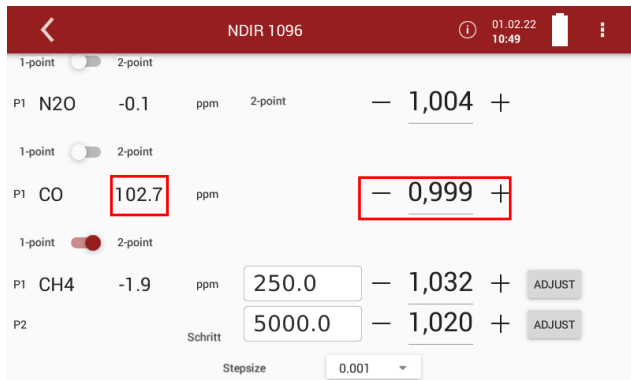

- ▶ Wait until a stable gas value is reached.
 - ⇒ This usually takes three to five minutes.
- ▶ Using the plus/minus keys, adapt the adjustment factor until the value of the applied test gas concentration is reached. If necessary, change the resolution under Stepsize

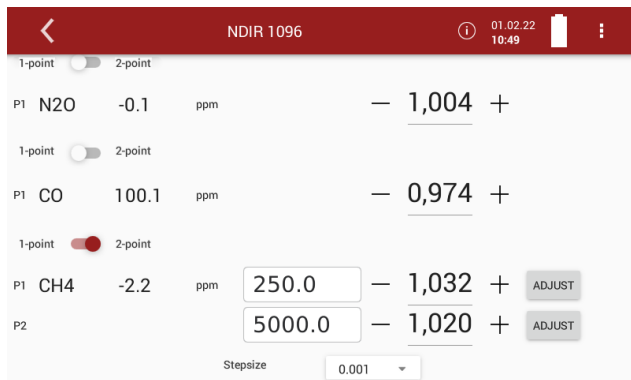

- ▶ Exit the adjustment window.
 - ⇒ A button appears in the display.

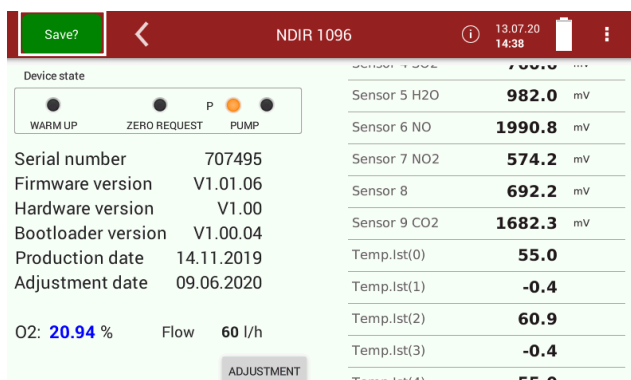

► Press Save?

⇒ The adjustment factors are saved.

NOTE



You have the possibility to export the adjustment factors.

☞ See also chapter Export NDIR- Factors, Page 92.

13 Maintenance and cleaning

13.1. Cleaning and maintenance

The analyser needs only low maintenance effort for long value preservation:

⚠ CAUTION



Acid from the condensate

Acid burns may result from weakly acidic liquids from the condensate.

- ▶ If you come into contact with acid, wash the area immediately using a lot of water.
- ▶ Note the safety data sheet for phosphoric acid (10%).

NOTE



Please note that correct operation of the analyser is only ensured if the sensors are adjusted regularly.

- ▶ Depending on the intensity of use, the sensors have to be adjusted / calibrated 1-2 times a year.

After every measurement:

- ▶ Remove the gas sampling tube from the analyser, so that the hose can dry.
- ▶ Check the filter in the probe head. Replace the filter if necessary.

Occasionally:

- ▶ Clean the probe and the probe hose.
- ▶ If the analyser was not used for a longer period of time, charge the battery first.
- ▶ Charge the battery approximately every 4 weeks.
- ▶ Check the round filter at the front of the instrument. Replace the filter if necessary.

13.2. Service check

An annual service check and if necessary, adjustment of the sensors at an MRU service department (www.mru.eu) are recommended for the preservation of value.

14 Transport and storage

If the analyser is transported or stored, you must take special precautions:

- ▶ Only transport and store the analyser in the transportation bag provided
- ▶ Avoid shocks when transporting the analyser.
- ▶ Switch off the analyser.
- ▶ Close all openings of the carrying bag.
- ▶ Store the analyser in a safe and dry place.
- ▶ Store and transport the analyser upright, as described in Measuring mode
- ▶ Store the analyser in the temperature range -20°C - $+50^{\circ}\text{C}$.
- ▶ Store the analyser in a maximum humidity range of 90% relative humidity, non-condensing.
- ▶ Protect the analyser from water spray.
- ▶ Protect the analyser from direct sunlight.
- ▶ Protect the analyser from unauthorized use.
- ▶ Store phosphoric acid 10 % not below 0°C

15 Simple service work

15.1. Information of the analyser components

Information about analyser components is helpful in case of service or inquiries.

► Touch  .

⇒ A selection list appears.

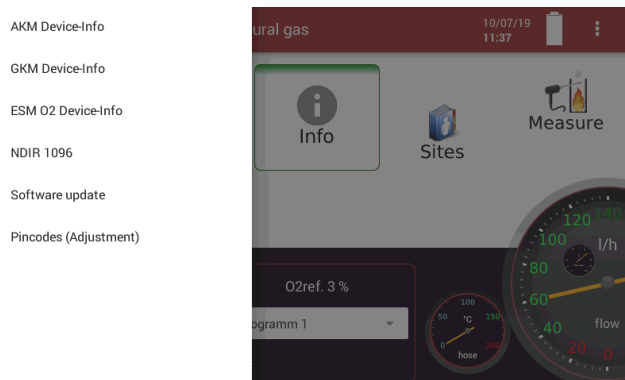

► Choose the desired component of the analyser.

⇒ The information about the component of the analyser is displayed.

AKM Device-Info		10/10/19 14:49	87
AK-Modul		4-20mA out1	20.0
Serial number	750098	4-20mA out2	0.0
Firmware version	V1.01.01	4-20mA out3	4.0
Hardware version	V1.00	4-20mA out4	0.0
Bootloader version	V0.00.01	4-20mA out5	2.0
Production date	15.08.2017	4-20mA out6	20.0
Adjustment date	06.02.2106	4-20mA out7	4.0
		4-20mA out8	0.0
		4-20mA in1	-0.0 mA
		4-20mA in2	-0.0 mA

15.2. Updating the firmware

If necessary, you will receive a new released data package from the manufacturer for updating the firmware and the individual modules. The data package consists of a ZIP data package. The data package has the ending .mru.

Update main firmware

- ▶ Copy the data package to a USB stick.

NOTE



You can also save the data package in subfolders. The analyser will search the folder structure on the USB stick up to the second hierarchy level. Save the data package in the folder structure above, if the option file is not is displayed

- ▶ Connect the analyser to the power supply.
- ▶ Switch on the analyser.
- ▶ Insert the prepared USB-stick into a USB socket of the analyser.
- ▶ Press
- ⇒ A selection list appears.
- ▶ Press Software update.
- ⇒ A window appears.

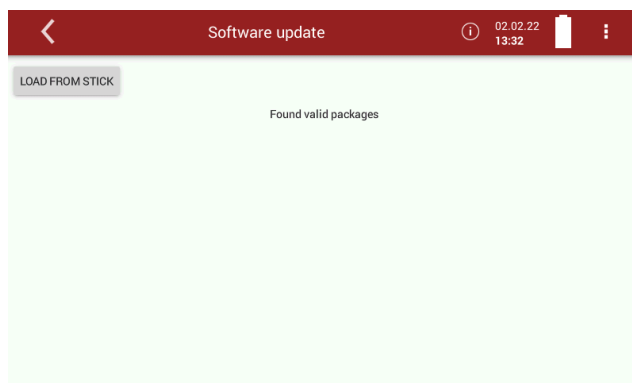

NOTE



Please note that you must first update the main firmware. After the restart you can update the modules.

- ▶ Press LOAD FROM STICK
- ⇒ A message appears.

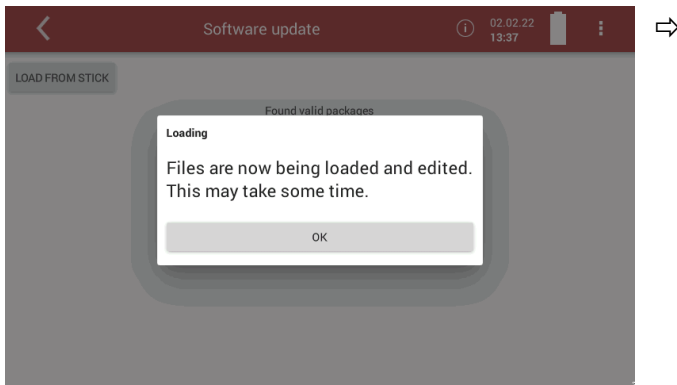

► Press OK.

⇒ A window appears.

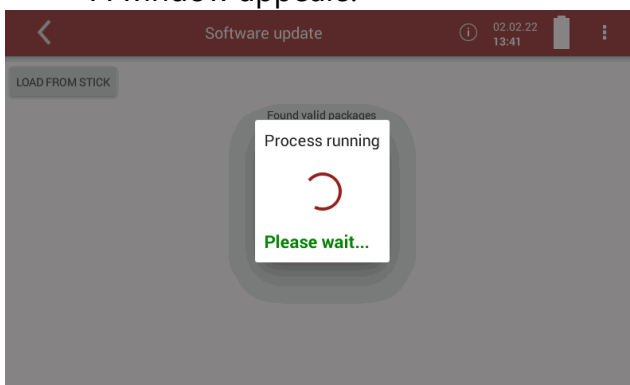

► Wait until the loading process is completed.

⇒ After the loading process is completed, a message appears.

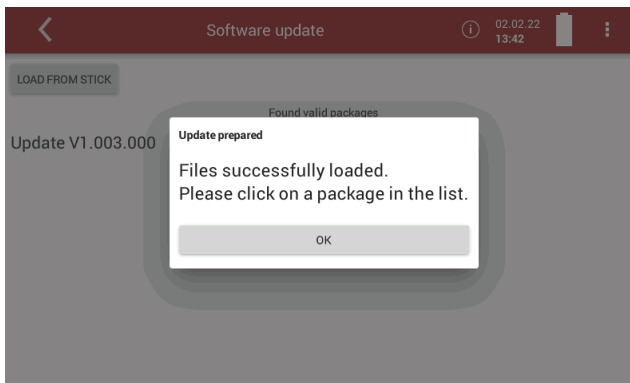

► Press OK.

⇒ The valid data packages found are displayed.

NOTE



If no data package is displayed, save the received data package again on a USB stick.
If the data package is not displayed again, contact customer service or one of the MRU-Service partners worldwide.

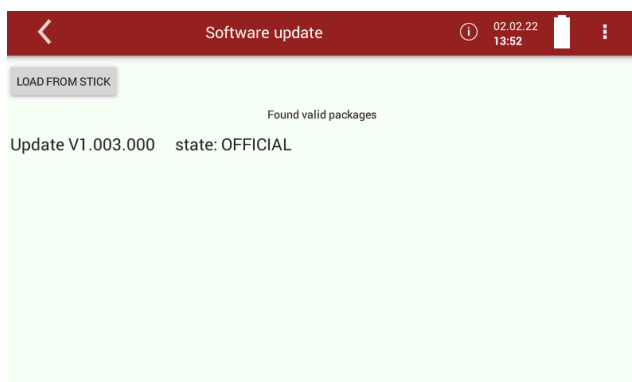

► Select the desired data package.

⇒ A window appears.

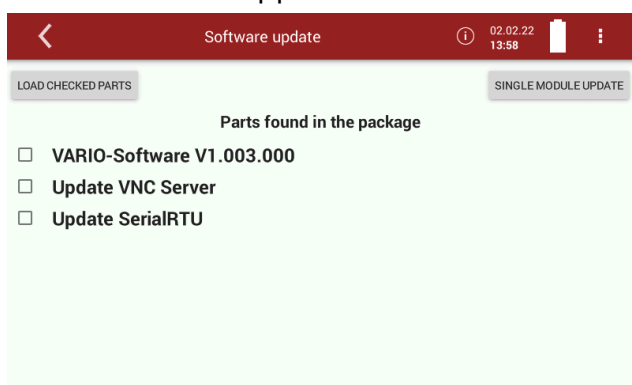

► Select parts of the data package that you want to update.

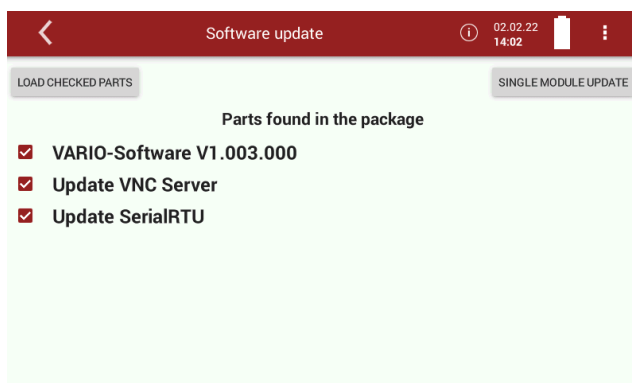

► Press LOAD CHECKED PARTS

⇒ A message appears.

⇒ To conclude the update process, the analyser must be restarted.

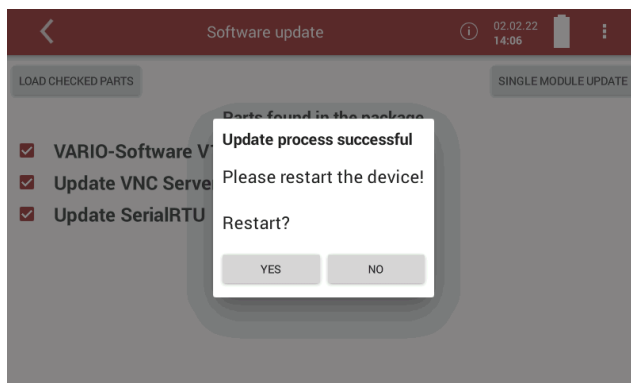

► Press YES.

- ⇒ The analyser performs a restart.
- ⇒ You can now update the software of single modules.

Update firmware of single modules



NOTE

Note that you must first update the main firmware. After restarting, you can update the firmware of single modules.

► Go to the window Software update.

- ☞ See also chapter Update main firmware, Page 108.

► Perform the steps as described in the chapter Update main firmware until the following window appears.

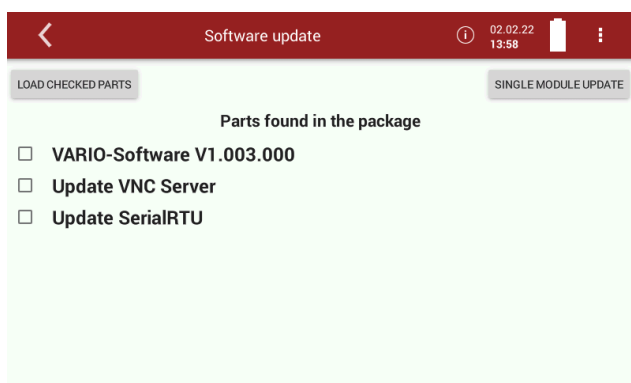

► Press SINGLE MODULE UPDATE.

- ⇒ A window appears.

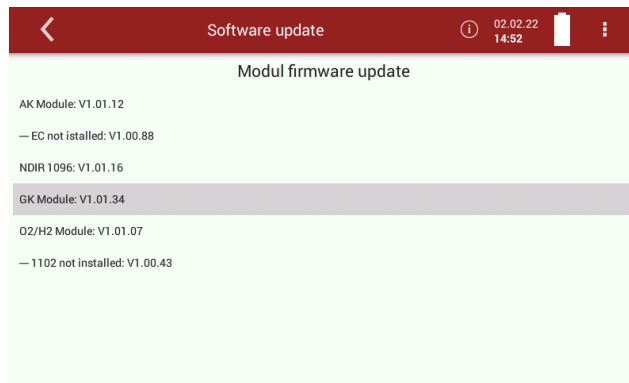

- ▶ Select the desired module that you want to update.
- ⇒ A message appears.

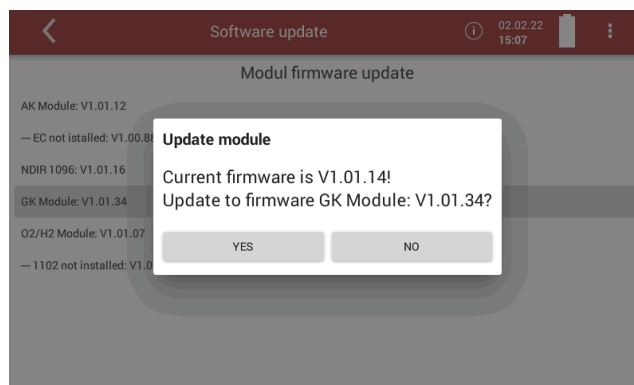

- ▶ Press YES.
- ⇒ The update is started.



- ⇒ After the update has been performed successfully, a message appears.

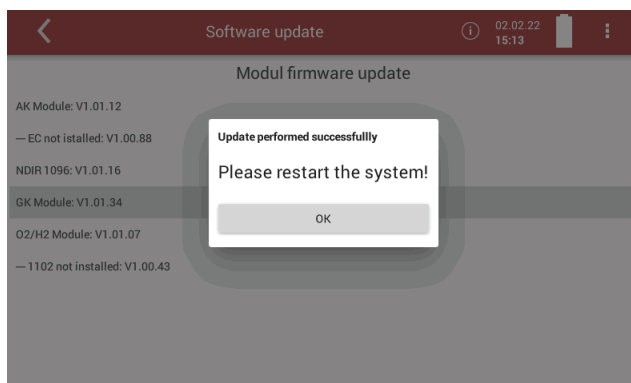

- ▶ Press OK.
- ▶ Please restart the system.

16 Specifications

16.1. Specifications of NDIR technology

T90 / s 160						
Gas	Measuring Range 0 - min ... max	Certification range / additional range	Resolution	Repeatability	8h-Drift	Linearity
NO	0 - 200...4.000 ppm	0 - 200 / 2.000 ppm	0,1 ppm	2ppm / 1% rdg.	2ppm / 1% rdg.	1% m.r.
NO ₂	0 - 150...1000 ppm	0 - 150 / 500 ppm	0,1 ppm	1ppm / 1% rdg	2ppm / 1% rdg.	1% m.r.
SO ₂	0 - 150...4.000 ppm	0 - 150 / 3.000 ppm	0,1 ppm	2ppm / 1% rdg.	2ppm / 1% rdg.	1% m.r.
CO ₂	0 - 40 Vol%	0 - 20 Vol%	0,01 Vol%	0,2 Vol% / 1% rdg.	0,2 Vol% / 1% rdg.	1% m.r.
CO	0 - 175...10.000 ppm	0 - 175 / 3.000 ppm	0,1 ppm	2ppm / 1% rdg.	2ppm/ 1% rdg.	1% m.r.
N ₂ O	0 - 100...500 ppm	0 - 100 / 250 ppm	0,1 ppm	2ppm / 1% rdg.	2ppm/ 1% rdg.	1% m.r.

16.2. Sensors for Oxygen, Temperatures and Pressure⁷

Paramagnetic Sensor	O₂
Measuring Range	0 - 25 Vol%
Resolution	0,01 Vol%
Accuracy	0,1 Vol%
Flue gas temperature	T_A
Measuring Range with high grade steel probe pipe	0 – 800° C
Measuring range with Inconel probe pipe	0 – 1100° C 0 – 1350° C
Short time only (up to 20 mins)	
Accuracy abs. / reading	±2° C / 1%
Air temperature	T_I
Measuring Range	0 – 100°C
Accuracy	1 °C
Differential Pressure	
Measuring Range	± 120 hPa
Accuracy abs. / reading	0,02 hPa / 1 %
Barometric Pressure* (only available with the option flow velocity measurement)	P_{abs}
Measuring Range	300 – 1200 hPa
Accuracy	± 3 hPa

16.3. Gas sampling and conditioning

Max suction range gas pump	300 hPa
gas flow	60 l/h
Double Stage Gas cooler	•
Temperature Peltier cooler (during grid and battery operation)	4 °C
Batt operating hours with gas cooler	2h
Condensate removal from gas cooler	•
Humidity supervision and alarm	•
Internal gas flow measurement	•
Gas outlet (Vent port)	•
Passive	3 mm

⁷ The measured value O₂ is part of the proof according to DIN EN 15267-4.

The measured values air temperature, flue gas temperature, differential pressure and barometric pressure are not part of the proof according to DIN EN 15267- 4.

See also chapter 2.1 Intended use, Page 8.

16.4. Calculated values and accessories⁸

Measurement values available as	mg/Nm ³ O ₂ Ref mg/kWh NOx: mg/Nm ³ NO ₂
Velocity based on differential pressure measurement with Pitot tube	v
Typical measuring range	3 m/s ... 100 m/s
Accuracy at 3m/s.	1 m/s
Accuracy > 12 m/s (reading)	± 1%
Resolution	0,1 m/s
Absolute pressure measurement	•

16.5. Data communication

USB interface master only (for connection to USB stick or accessories)	•
Ethernet, RJ45	•
WLAN	•
RS485 (AUX socket, for connection of external sensor modules)	•
RS485 (isolated, for connection to PC)	•
Analog I/O: 4x input, 8x output, 4... 20 mA	•

16.6. Technical data

Operating temperature	+5°C ... +40 °C
Rel. Humidity, non-condensing	90%
Storage Temperature	-20 °C ... +50 °c
Internal Battery Pack, capacity, operating hours w/o gas cooler and heated sample line	Li-Ion, 96 Wh
Charge time (1 Battery pack)	3h = 90%; 5h = 100%
Display	7 touch, 750 cd/m ² 800*480 px
Power supply (w/o heated sample line)	86 ... 265Vac / 47...63Hz / 105W
Power consumption (with 5m heated sample line)	300 W typical (600 W max.)

⁸ The velocity (v) and the measured values O Ref, mg/kWh, NOx:mg/Nm³.
NO₂, mg/Nm³ are not part of the proof according to DIN EN 15267-4.
See also chapter 2.1 Intended use, Page 8.

Weight incl. Case	15,0 kg
Size incl. Case (WxHxD)	46cm x 33 cm x 20 cm
Housing Material	Aluminium / TPU
Material Protection Bag	Nylon
IP degree of protection incl. protection bag	IP42

16.7. Technical data Acid Dosing Unit APE

Operating temperature	+5°C ... +40 °C
Rel. Humidity, non-condensing	90%
Storage Temperature	-20 °C +50 °C
Power supply #12788	207 ... 253Vac / 47...53Hz / 15W
Power supply #12788US	99 ... 140Vac / 47...63Hz / 15W
Weight	2,5 kg
Total liquid flow	24 ml/h
Size (WxHxD)	32x12,5x17cm
Housing Material	PC
IP degree of protection	IP42

17 Options

17.1. Gas flow measurement⁹

With the option Gas flow measurement further measured values are available:

- v-flow
- Flow rate

Connect analyser to Pitot tube

The following sketch shows an example of the connection of the analyser to a Pitot tube with thermocouple.

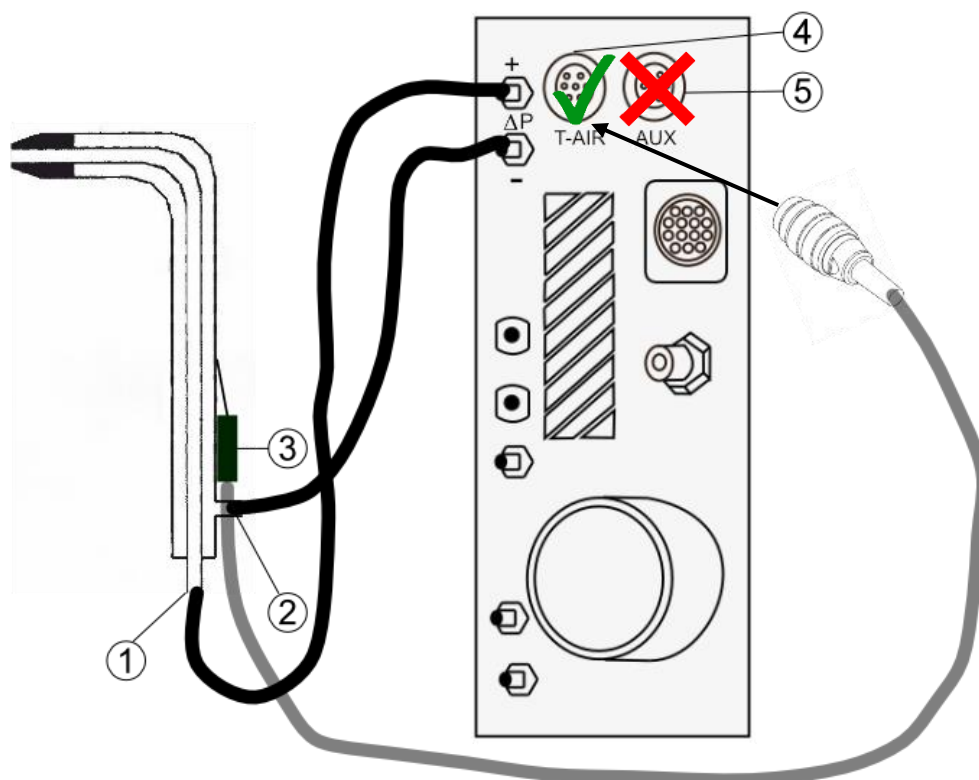

Position	Description
1	Connection total pressure
2	Connection static pressure
3	Thermocouple
4	Connection T-AIR
5	Connection AUX

⁹ The Gas flow measurement option is not part of the proof according to DIN EN 15267-4. See also Chapter 2.1 Intended use, Page 8



NOTE

Note that the AUX connection is intended exclusively for use with the Acid Dosing Unit APE.

Parameter for gas flow measurement

- ▶ Touch the menu Measure.
 - ⇒ The measurement window appears.
- ▶ Touch the "Context menu" (19).
 - ⇒ A selection list appears.

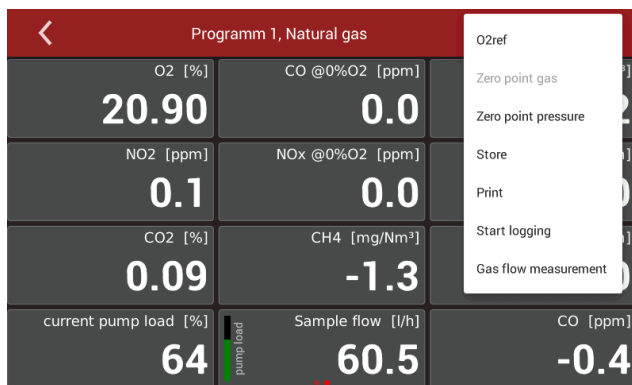

- ▶ Touch „Gas flow measurement“.
- ⇒ A setting window appears.

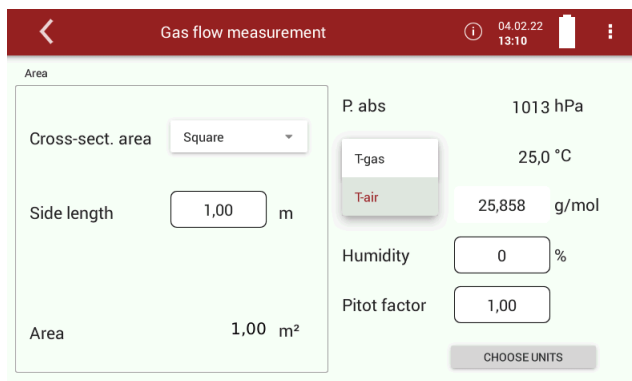

- ▶ Change the desired parameters.

NOTE

You have the following options for measuring the temperature:



- Via the probe (T-gas)
- Via the connection T-AIR.
- ☞ See also chapter Connect analyser to Pitot tube, Page 118.

- ▶ Touch „CHOOSE UNITS“.
- ⇒ A setting window appears.

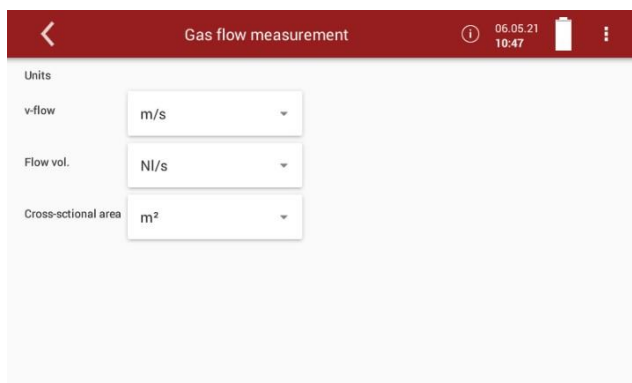

- ▶ Change the desired unit.
- ▶ Go back.
- ⇒ The change will be saved

17.2. Operating analyser with Nickel Metal Hybrid (NiHM) Battery

- ▶ Please note that the following information is only relevant for you if an optional NiHM-Battery is installed in your analyser.

The NiHM-Battery is mounted in the analyser instead of a Lilon-Battery. The optional NiHM-Battery is intended for air travel, because the Regulations for the transport of Lilon-Battery during air travel can often be problematic.

- ▶ Note that the NiHM-Battery is not intended for measurement operation, as only a limited Battery life is available.
- ▶ Measure only with a connected power supply.
Note that the analyser can be used for about 30 minutes in battery mode.
- ▶ Use the analyser in battery mode only for short measuring point changes. Furthermore, short power failures can be bridged by battery mode.
- ▶ The analyser displays a message if no power supply is connected.

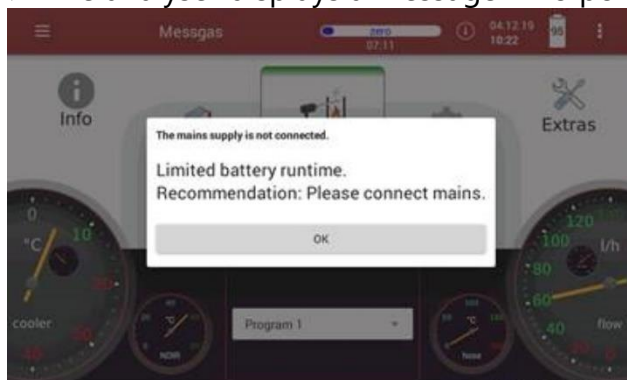

- ⇒ The message appears 45 seconds after switching on.

- ⇒ The message appears after 90 seconds if the power supply unit is removed during operation.

17.3. RS485 Extern

RS485 interface with modbus RTU protocol for far distance data transfer over cable.

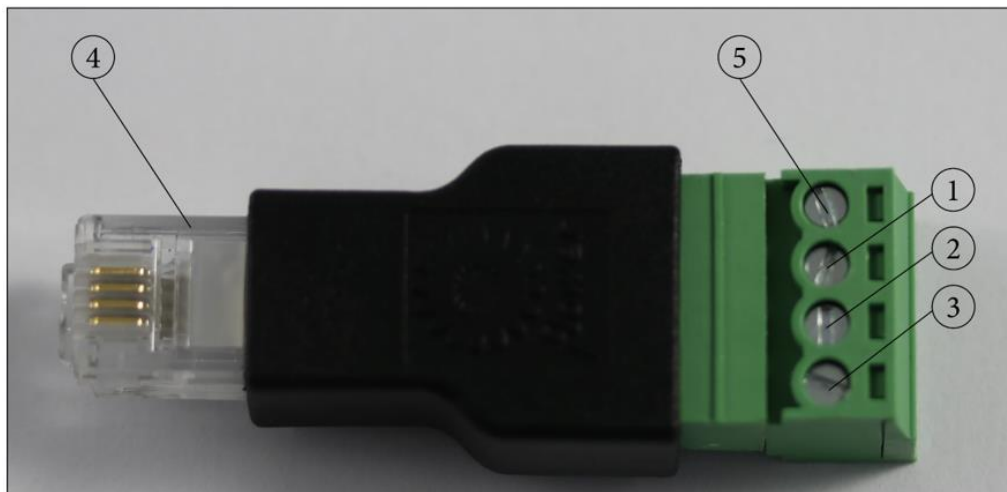

Electrical connections:

- 1 = A+
- 2 = B-
- 3 = GND
- 4 = Connector to RS485 port (option)
- 5 = Not used

NOTE: one twisted pair of shielded cable is user scope

Port settings:

Baud Rate: 19200

Data bits: 8

Parity: Even

Stop bits: 1

Slave ID: 1

Modbus slave specification:

- The analysers are able to work as modbus slave using modbus over RS485
- data types (used in table below):
 - A ASCII characters
 - U 16 bit unsigned integer value (0...65535)
 - I 16 bit signed integer value (-32768...32767)
 - UL 32 bit unsigned integer value (0...4.294.967.295)
 - L 32 bit signed integer value (-2.147.483.648...2.147.483.647)
 - F 32 bit floating point value (reads -1E38, when not available)-

17.4. Screw adapter onto HPI-Probe (Option)

With the adapter you have the possibility to use heated probe tubes from other manufacturers.

The adapter is available in 3/8-inch and 3/4-inch sizes.

When screwing the adapter onto the HPI probe, pay attention to the size of your probe tube.

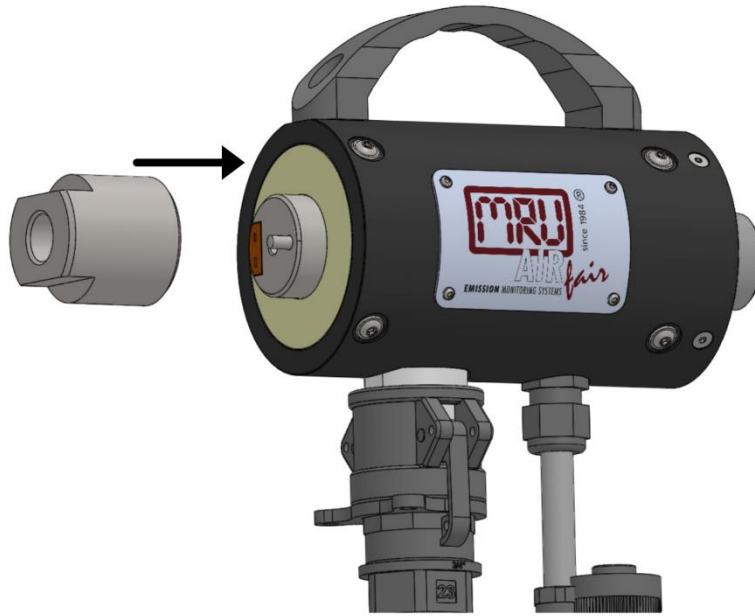

- ▶ Screw the adapter onto the HPI probe.
- ▶ Screw your probe tube onto the adapter.

18 Appendix

18.1. Error diagnosis regarding the measuring instrument

Fault indication	Possible causes	Repair
Gas cooler is faulty! The system will shut down.	Gas cooler faulty.	Contact MRU service department.
Undervoltage!!! The System will shut down	Battery is discharged.	Connect instrument to power grid.
Power consumption too high Please check heated hose!	Please check heated sample line.	Heated sample line may be damaged. Disconnect the instrument from power grid and visually inspect the sample line. Take care to unroll the heated sample line before operating it.
Please wait – pump is off Warm up has not been completed yet.	Measurement not started as instrument is in warm-up phase.	Wait until warm up phase has terminated.
Flow monitoring! Flow rate too low! Please check filter.	The sample gas flow has fallen below the required limit. Filter or sample line may be clogged. Gas pump may be faulty Flow sensor may be defect.	Check sample line and all filters on dust or water. Replace filters.
Gas cooler is drying out.	Typically occurs when dry test gas or dry ambient air is measured over a longer period of time (several minutes) instead of flue gas. Can only occur during operation without acid injection.	Use a test gas humidifier. Use acid injection.

18.2. Condensate alarm

A condensate alarm occurs as soon as water is detected in the gas duct. In this case, the measurement can be implausible.

A condensate alarm that has occurred can be eliminated in a two-step process.

After a condensate alarm occurs, the analyser attempts to remedy the problem independently by means of a "condensate self-help" and to switch back to measuring mode

If the "condensate self-help" was not successful and there is still water in the gas duct, you must start a drying of the gas duct manually.

Condensate self help

With "condensate self-help" you do not have to actively initiate any steps. The measuring analyser carries out the "condensate self-help" independently.

As soon as water is detected in the gas duct, the analyser displays a message.

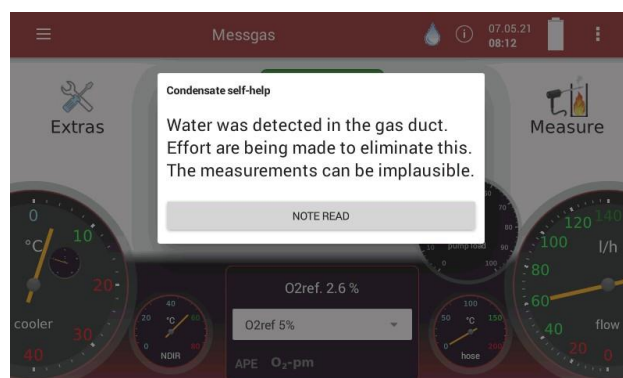

- ⇒ The "Condensate self-help" is performed.
- ⇒ As soon as the "Condensate self-help" has been successfully completed, a message appears.

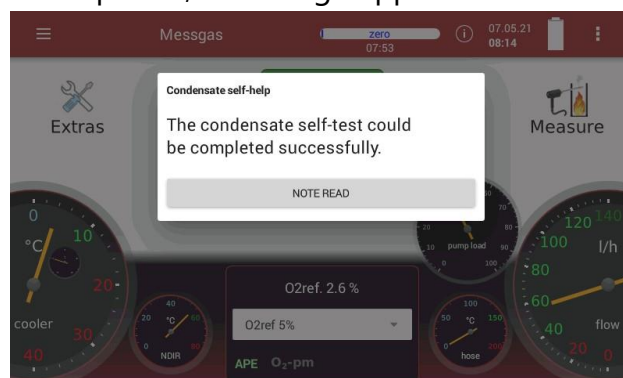

- ⇒ A zero point measurement is started automatically.

You can display the start and end of the "Condensate self-test"



⇒ A window appears.

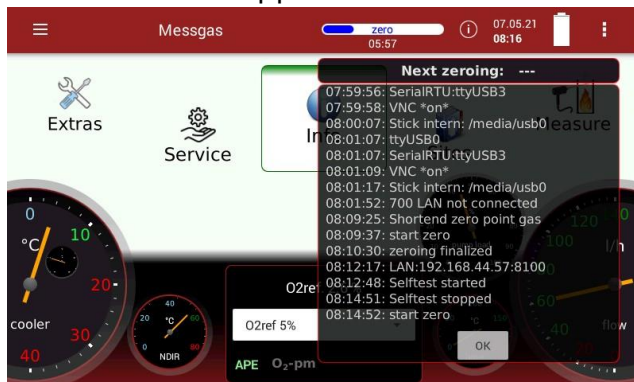

Start drying manually

If the "condensate self-help" was not successful and there is still water in the gas duct, you must start a drying of the gas duct manually. A corresponding message is displayed and an acoustic signal sounds.

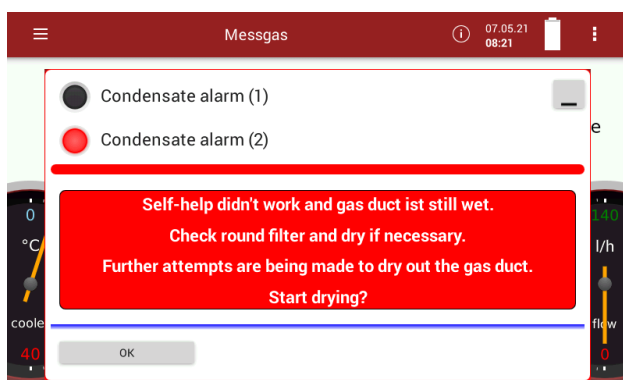

CAUTION

Acid from the condensate

Acid burns may result from weakly acidic liquids from the condensate.



- ▶ If you come into contact with acid, wash the area immediately using a lot of water.
- ▶ Note the safety data sheet for phosphoric acid (10%).

NOTE



- ▶ Dispose of acidic condensate and phosphoric acid in accordance with national and, if necessary, local disposal guidelines.

- ▶ Remove the round filter.
- ▶ Dry the round filter, if necessary.
- ▶ Press OK.

⇒ A window appears

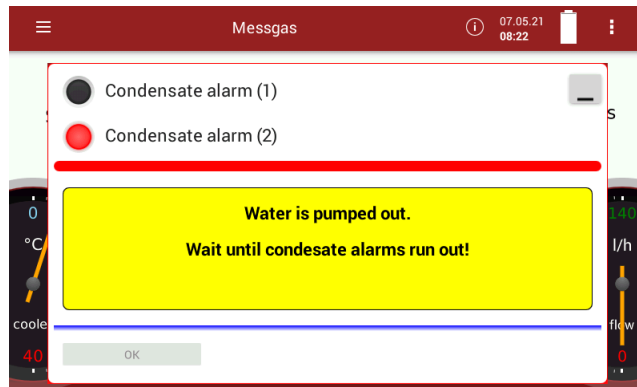

► If necessary, repeat the procedure if another message is displayed.

⇒ A message appears, as soon as gas duct is dry again

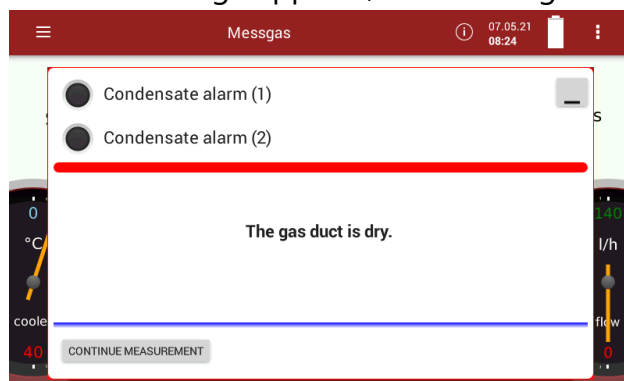

► Press CONTINUE MEASUREMENT.

⇒ A zero point measurement is started automatically.

18.3. Switching off the analyser in case error

If the touch screen does not respond, you have two options for switching off the analyser:

- ▶ Touch the ϕ button during flashing LED for 30 sec. minimum
- ▶ After change to continuous lighting, release the ϕ button
 - ⇒ The instrument will be switching off with reset.

Alternatively, you can switch off the analyser as follows:

- ▶ Press the reset button on the right side of the analyser.
 - ☞ See also the illustration in 3.4 Connectors, Page 14.

Further information about the defined registers on demand (www.mru.eu) and on the device supplied USB stick!

18.4. Connecting analyser with MRU4win

The analyser is a Modbus device.

- ▶ You can connect Modbus devices with MRU4win via a serial interface (RS 485).
 - ☞ See also Chapter 17.3RS485 Extern, Page 121.
- ▶ You can connect Modbus devices to MRU4win via a TCP/IP connection.
 - ⇒ The TCP/IP connection can be made by LAN or WLAN.

Connecting analyser with MRU4win via serial interface (RS 485).

- ▶ Connect the electrical connections of the RS485 interface as described in Chapter .17.3RS485 Extern, Page 121.
- ▶ Connect the analyser to your PC via the RS485 interface.
- ▶ Open the Menu Device settings.
 - ☞ See also Chapter 5.4 Device settings, Page 27
- ▶ Set "Modbus Slave ID" to 1.
 - Please note that the Modbus slave ID is a consecutive number.

If the number 1 is already assigned, assign "Modbus Slave ID" 2 etc. to the analyser.

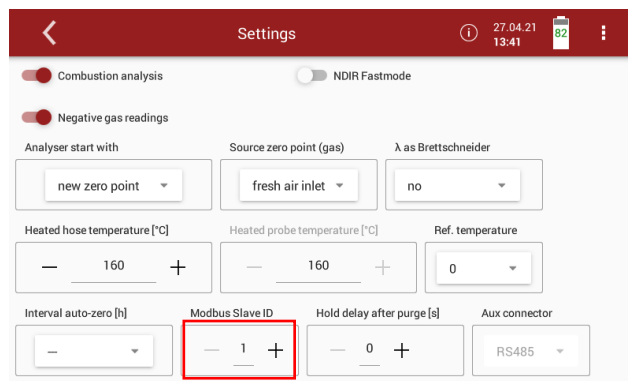

► You can now create the analyser in MRU4win.

☞ See also Chapter Creating analyser in MRU4win, Page 129.

Connecting analyser with MRU4win via TCP/IP connection

Before you can connect the analyser with MRU4win via a TCP/IP connection, you have to read out the IP address in the analyser.

► Connect the analyser to the network.

⇒ The connection can be made via LAN or WLAN.

☞ See also Chapter 5.11 Connecting analyser with WIFI (WLAN), Page 43.

► Touch the "Context menu" (19).

⇒ A selection list appears.

► Touch "Display settings".

⇒ An overview screen appears.

⇒ In the top line, the IP address of the analyser is displayed.

In this example the LAN address is 192.168.44.38.

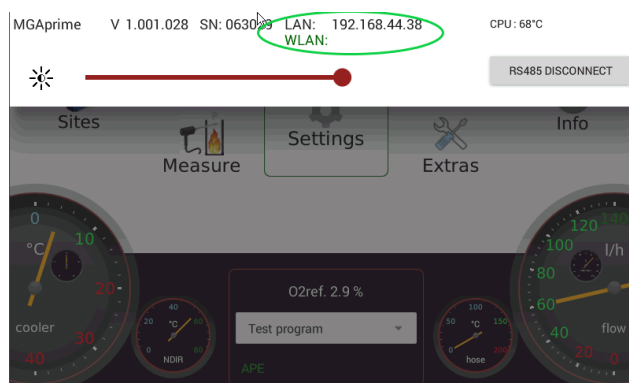

► Switch to the Settings menu.

► Set "Modbus Slave ID" to 1.

Please note that the Modbus slave ID is a consecutive number.

If the number 1 is already assigned, assign "Modbus Slave ID" 2 etc. to the analyser.

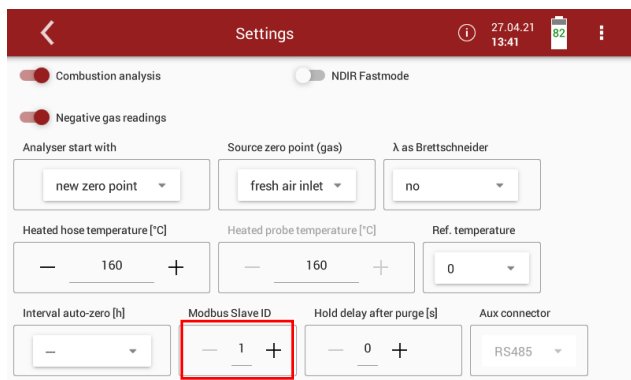

► You can now create the analyser in MRU4win.

☞ See also Chapter Creating analyser in MRU4win, Page 129

Creating analyser in MRU4win

Modbus devices are not automatically identified in MRU4win. Before you can the analyser with MRU4win, you have to create a Modbus device.

► Open MRU4win.

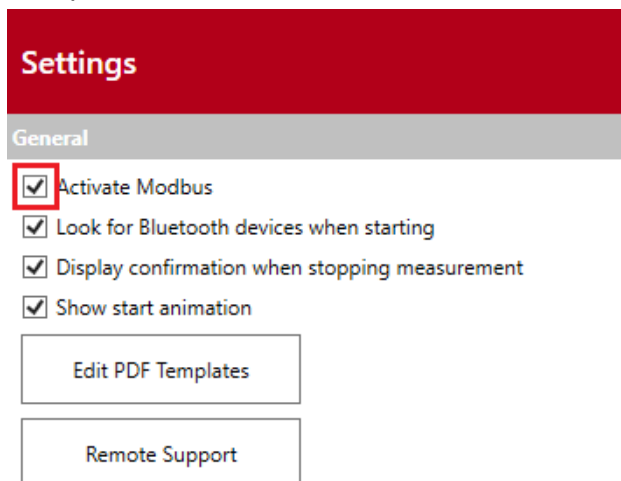

► Set under Settings "General" a check mark at "Activate Modbus".

► Click "Create Modbus Device".

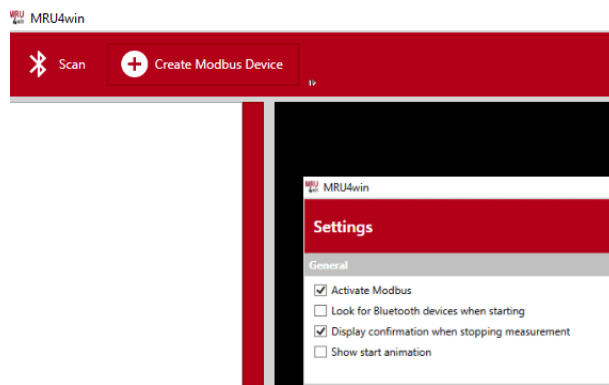

⇒ A window appears.

- ▶ You can connect the analyser with MRU4win via a serial interface or via a TCP/IP connection.
- ▶ Select the desired connection type under " Serial/TCP".
If you select the connection type "TCP", the input window changes.

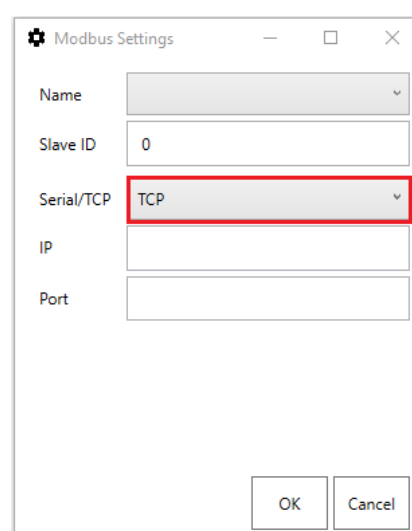
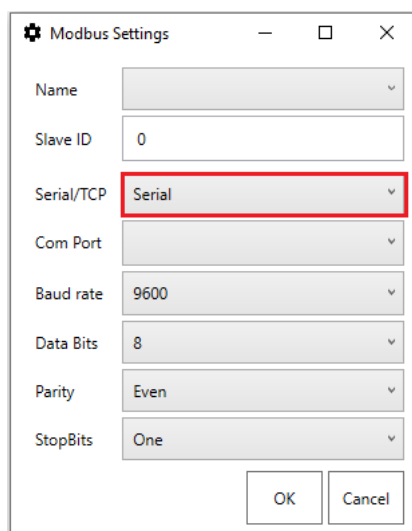

- ▶ Choose "Name"

⇒ A selection list appears.

- ▶ Choose "1113 Device".
- ▶ Set "Slave ID" to 1.

Note that the slave ID must match to the "Modbus Slave ID" of the analyser. For example, if the analyser has the "Modbus Slave ID" 2, the "Slave ID" in MRU4win must be set to 2.

- ▶ If necessary, enter your IP address, if you want to set up a TCP/IP connection.

In this example the LAN address is 192.168.44.38.

☞ See Example in Chapter Connecting analyser with MRU4win via TCP/IP connection, Page 128.

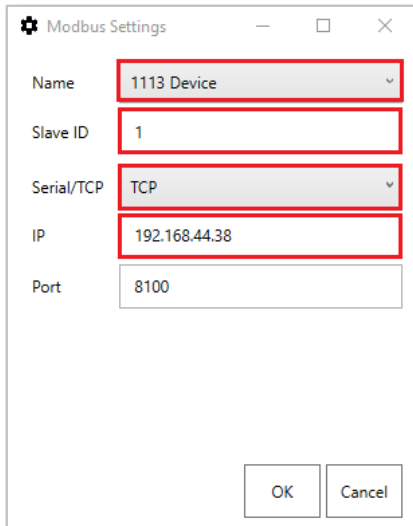

- ▶ Click "OK".
- ▶ Go to Livemeasurements
 - ⇒ The analyser appears in the column of available analysers.

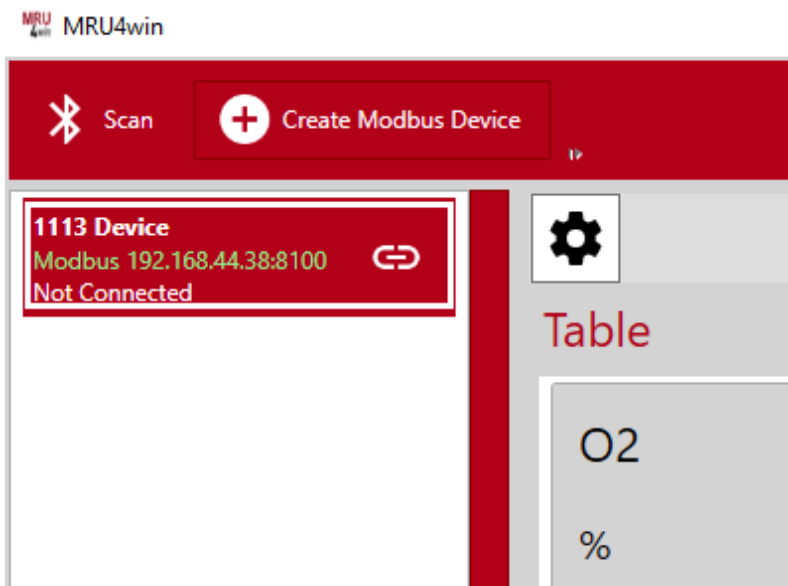

- ▶ Click on the "Connect-Icon" 
 - ⇒ The analyser is connected.

18.5. Remote control of the analyser device via VNC

► Activate WLAN-Hotspot (android)

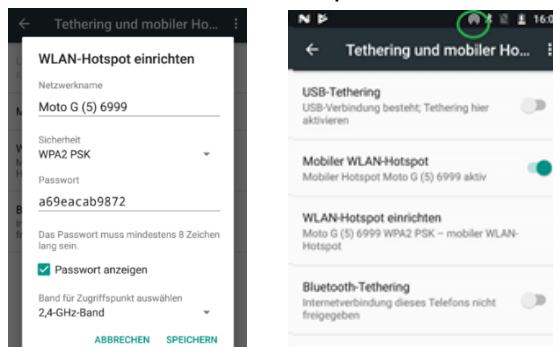

► Install VNC viewer

► Configure VNC viewer

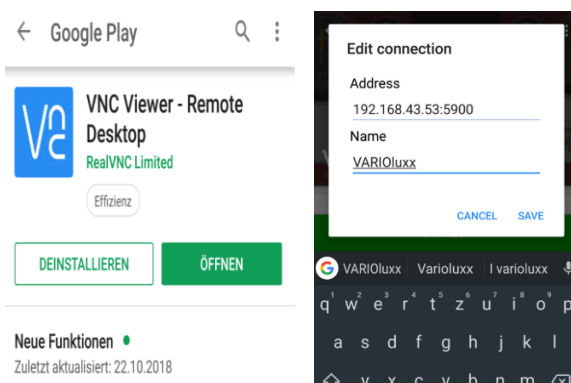

► Connect to device

► Activate VNC on Analyser

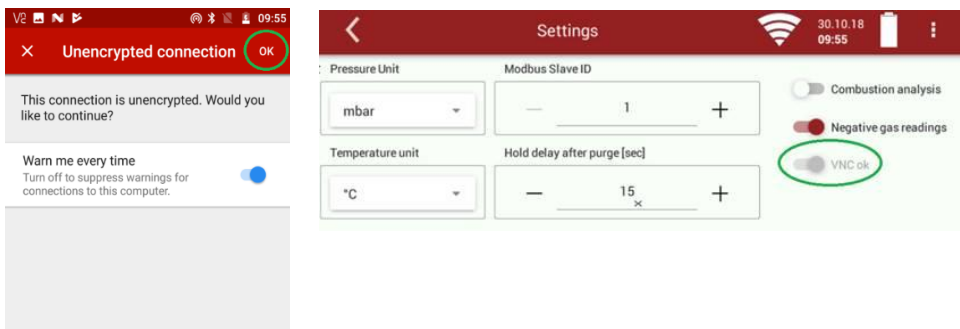

► Use remote control via Android device

NOTE



Please note that due to the increased computing power, the CPU temperature will increase. If the temperature should become too high, the VNC server switches off automatically.

18.6. CxHy Calculation

The calculation for CxHy is:

- if CH₄ and C₃H₈ are present: CxHy = CH₄ + C₃H₈.
- if only one HC - channel is available, CxHy is equal to it.

18.7. General Instructions for the heated hose line

For the save operation of the sample line it is important that it is installed correctly. This includes the following points:

- The bending radius as given below is maintained,
- The entire heated hose line is rolled out before put into operation,
- Both ends of the heated hose line are connected correctly,
- For thermal and mechanical reasons, it shall be supported by a cable duct along the line,
- The heated hose line shall be supported close to the analyser cabinet and probe housing, for example by using a separate stilt,
- There are no extreme temperature variations along the line, as the line's temperature is regulated depending on a sensor placed in the mid of the line.

Unrolling the heated hose line

A wrong and careless use of the heated hose line may cause damage. Especially on very long heated hose lines the right unpacking and rolling out is important.

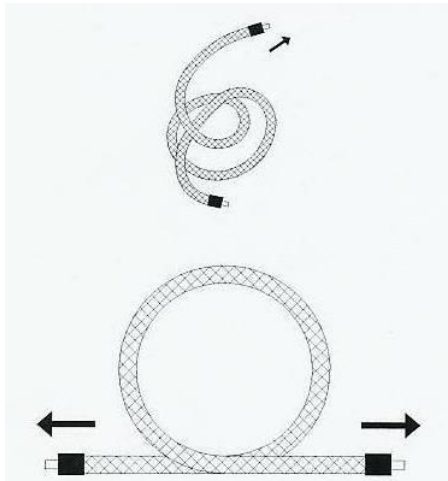
Wrong

Don't tear the heated sampling line out. ->
Cause sharp kink.

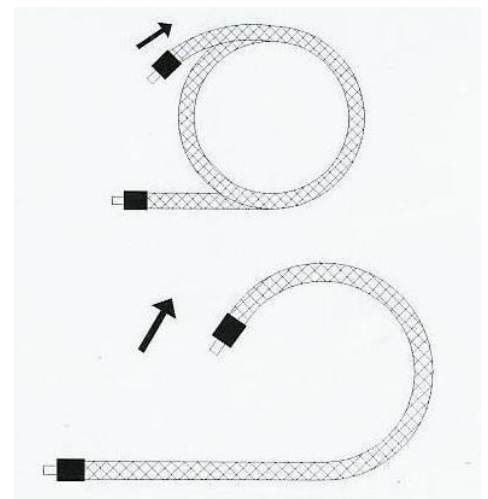
Right

Roll the heated hose line
smooth out.

Bending radius of heated sampling lines

The picture below shows the minimal bending radius.

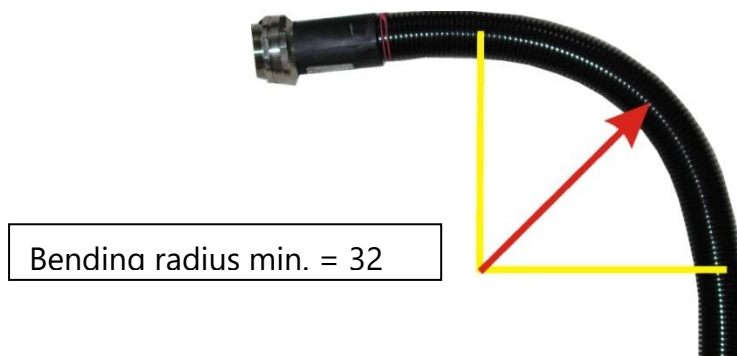

ATTENTION

Falling below the bending radius will reduce life time of the sampling probe.

18.8.Spare parts

Part number	Spare part
56879A	PTFE Round filter
61158	Probe filter sintered metal 2 μm
61157	Probe filter sintered metal 20 μm
10825	Mineral wool filter element
59799	O-Ring 16 x 1,5
61066	O-Ring 12 x 2
61333	O-Ring 10 x 2
60074	O-Ring 8 x 2

19 Declaration of conformity

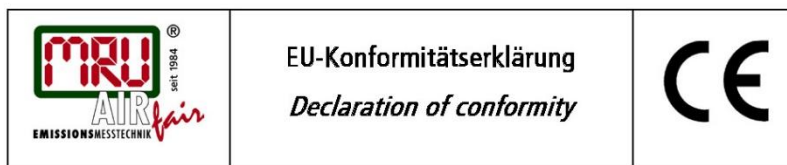

MRU Messgeräte für Rauchgase und Umweltschutz GmbH



Fuchshalde 8 + 12
74172 Neckarsulm-Obereisesheim
Deutschland / *Germany*
Tel.: +49 (0) 7132 - 99 62 0
Fax: +49 (0) 7132 - 99 62 20
E-Mail / *mail*: info@mru.de
Internet / *site*: www.mru.eu



Bevollmächtigte Person, für die Zusammenstellung der technischen Unterlagen
Person authorized to compile the technical documents

Name / *name*: Dierk Ahrends
Funktion / *function*: QM-Beauftragter / *QM- Representative*
Firmenname / *company*: Messgeräte für Rauchgase und Umweltschutz GmbH
Straße / *street*: Fuchshalde 8 + 12
Ort / *city*: 74172 Neckarsulm
Land / *country*: Deutschland / *Germany*

Produkt/Product

Bezeichnung / *designation*: Gasanalysator
Gas analyser
Produktname / *name*: **MGA**prime-Q
Funktion / *function*: Gasanalyse / *gas analysis*

Hiermit erklären wir, dass das oben beschriebene Produkt allen einschlägigen Bestimmungen entspricht, es erfüllt die Anforderungen der nachfolgend genannten Richtlinien und Normen:

We declare the conformity of the product with the applicable regulations listed below:

- EMV-Richtlinie / *EMV-directive* 2014/30/EU
- Niederspannungsrichtlinie / *low voltage directive* 2014/35/EU
- RoHS-Richtlinie / *RoHS directive* 2011/65/EU (RoHS II)

Neckarsulm, 22.01.2019



Erwin Hintz, Geschäftsführer / *Managing Director*



**MRU · Messgeräte für Rauchgase
und Umweltschutz GmbH**

Fuchshalde 8 + 12

74172 Neckarsulm-Oberreisesheim

Fon 07132 99620 · Fax 07132 996220

info@mru.de · www.mru.eu